



Play, Lead, Compete

TENNIS SATELLITE
CLUBS TOOLKIT

LTA **BRITISH TENNIS**
IN PARTNERSHIP
Tennis
FOUNDATION

Contents

- Introduction.....03
- Playing 13
- Leading.....213
- Competing.....217

About Us

The Tennis Foundation is Great Britain's leading tennis charity. Our vision is a sport which is truly inclusive and accessible to every kind of community. Our aim is to provide opportunities to encourage people to maximise their potential through tennis. We work closely with the Lawn Tennis Association (LTA) and a wide range of partners from across all sectors to deliver our vision and aim. For more information please go to: www.tennisfoundation.org.uk

The Lawn Tennis Association (LTA) is the national governing body for British tennis. The LTA's mission is to get more people playing tennis more often and our role is to govern, develop and promote British tennis. The LTA was founded in 1888 as the national governing body of British Tennis. 125 years on, it continues to represent the interests of the sport. For more information please go to: www.lta.org.uk



Introduction

The 'Tennis Satellite Clubs Toolkit – Playing, Leading & Competing' has been developed to make running a Tennis Satellite Club as easy as possible.

This Toolkit is aimed at providing coaches with the tools to deliver Tennis Satellite Clubs, focussing on three key areas: PLAYING, LEADING & COMPETING.

The Toolkit contains a range of guidance, 'ready to go' lesson plans, 'mix and match' activity cards and templates to make running a Tennis Satellite Club as easy as possible.

At the back of the Toolkit you will also find a CD-ROM which includes copies of:

- [Guide to Tennis Satellite Clubs](#)
- [Tennis Satellite Clubs Toolkit – Playing, Leading & Competing](#)
- [Tennis Satellite Club Agreement](#)
- [Tennis Satellite Club Reporting - Guidance Sheet](#)
- [School Games Tennis Toolkit CD-ROM](#)

The Guide to Tennis Satellite Clubs is primarily aimed at community tennis venues, host sites and coaches involved in the delivery of Tennis Satellite Clubs, but it also contains lots of ideas and guidance for clubs wanting to make links with schools outside of this programme. Please refer to the above Guide for everything you need to know about the Tennis Satellite Club programme.

More info...

Including disabled young people

Many young disabled people have the ability to participate fully in tennis, with little or no adaptations. However, for some people with more limited functional and physical abilities, there are many ways in which tennis activities can be adapted to ensure that all young people enjoy their experience and can achieve. Each 'ready to go' lesson plan and 'mix and match' activity card within this resource provides guidance on how to make the activities easier and harder – providing a range of general, specific and equipment adaptations you can make when delivering tennis to young people with a range of abilities. The 'Inclusive Tennis' section within this resource also includes some useful factsheets, with specific information to support coaches using a 'Functional Approach' and the 'STEPS' framework to ensure all tennis sessions are inclusive and every young person can enjoy and achieve through tennis.

Guidance

Tennis Satellite Clubs aim to engage teenagers into tennis as a fun, inclusive and exciting sport, retain them in the sport for longer and transition them into community tennis venues so they can play more tennis, more often. Tennis can be delivered in a variety of formats to attract young people with limited experience of the full sized game and this toolkit provides coaches and activators with a selection of delivery methods and resources catering for young people at various entry points to the game: Short Tennis, Cardio Tennis, Tennis Xpress and Traditional Tennis.

One of the main objectives for Tennis Satellite Clubs is to ensure the programmes on offer are appealing and meet the needs of young people aged 14-25 who we are looking to attract and retain in tennis. Young people should be at the heart of the decision making process. This could involve young people helping to choose the type and format of activities they take part in, leading on aspects of the sessions or taking a lead off-court, for example on social media to help promote the Tennis Satellite Club.



Design Your Club



Design Your Club provides tips and ideas which focus on the ethos of consulting young people so that they get tennis on their terms! Activity organised by young people for young people, seems to have the best results in attracting and retaining them. Perhaps we need to be creative, try new things and give young people a sense of ownership – let's see if these elements can be the seeds of success to help us grow participation across this age group!

PLAYING, LEADING & COMPETING

Each Tennis Satellite Club will be expected to deliver a minimum of one activity from each of the three key areas throughout the course of the year: PLAYING, LEADING & COMPETING.

This Toolkit is split into sections so you can easily find and select the activities which best meet the needs of your participants.

- **'Ready to go' lesson plans** - for Short Tennis, Cardio Tennis and Traditional Tennis. These three sets of themed lesson plans each provide the structure and content for 6 lessons. They can be easily adapted and delivered in a flexible way to meet the needs of your Tennis Satellite Club.
- **'Mix and match' activity cards**
You can mix and match these activity cards to develop your own lesson plans and to help provide some additional ideas for activities. Most of the activities included on the 'mix and match' activity cards can be adapted to cater for Short Tennis or traditional tennis delivery.



HOW THE ACTIVITY CARDS WORK

There are 95 activity cards included in the toolkit and most of the activities can be adapted to cater for Short Tennis or traditional tennis, however to make it easier to select appropriate activities we have split the cards so they can either be found in the Short Tennis or traditional tennis sections of the toolkit.

All the cards are suitable for young people of all ages and abilities and can be used in a number of different ways. It is always best to start with the central activity outlined on the card and then, depending on the ability level of the young people taking part, make the activity easier or harder.

You could:

1. Build cards together to form a session.
2. Use the cards for additional / new ideas, to build into existing sessions.
3. Use the cards as part of a circuit activity session.
4. Use the ABCs, Challenges and Tricks cards as fun activities during promotional / taster sessions as they can be set up anywhere and don't require court space.



The activity cards cover the following topics:

- **ABCs** – for warm ups and fundamental movement skills (i.e. agility, balance, coordination and speed).
- **Challenges & Tricks** – fun racket and ball skills.
- **Main Themes** – for technique, tactics and playing the game.
- **Drills** – exercises for more advanced players on a full tennis court.
- **Fun Games** – inclusive, fun ideas to start or end a session.
- **Competition** – helping players get to grips with scoring and ways of winning points. The competition cards can also be used for sessions dedicated to competition.

Each card has some, or all of the following information:

1. Category – ABCs, Challenges & Tricks, Main Themes, Drills, Fun Games, Competition.
2. Learning objectives / outcomes.
3. Organisation, safety and equipment.
4. Activity or activities – sometimes there are alternative ways of doing the activity, which are equally as beneficial. If the activities are numbered, they are in a progressive order.
5. Easier & harder – how to make the activity easier or harder.
6. Quality points – points you need to look for and encourage.
7. Discover – questions you can ask to help the young people learn for themselves.
8. Competition – a competitive version of the activity to use in the last part of the session.

Each 'ready to go' lesson plan and 'mix and match' activity card within this resource provides guidance on how to make the activities easier and harder – providing a range of general, specific and equipment adaptations you can make when delivering tennis to young people with a range of abilities, especially those with additional functional or physical needs.



Inclusive Tennis

Tennis is a completely inclusive sport and nearly everyone can participate in tennis in its full format or when adapted. There are some simple considerations for coaches to incorporate into their session planning for working in a more inclusive manner. These take into account the type and severity of a participant's disability or long term limiting illness.

The 'Functional Approach' and 'STEPS' provide useful frameworks to follow in preparing tennis sessions for young disabled people.

Functional approach

- Consider the functional ability of the athlete.
- Assess the impact of this on their chosen sporting activity.
- Determine how the environment affects a person's functional ability.
- Look at what other factors can impinge on a person's ability to participate.

STEPS (considerations for inclusive tennis)

- Space – what is required to make the activity successful?
- Task – how can it be adapted to make it appropriate?
- Equipment – how can it be adapted to make it appropriate?
- People – are additional coaches or volunteers required?
- Speed – how quickly, if at all, should you progress?



WHEELCHAIR TENNIS

Space/ Environment	Tasks	Equipment/ Rules	People/ Communication	Speed of progress
Are the courts and facilities wheelchair accessible? Make sure wheelchair players can get off court in an emergency.	Can integrate with non-disabled players (only difference is that wheelchair players are allowed two bounces of the ball).	Specialised tennis wheelchairs, both manual and powered.	Recognise that wheelchair players have different abilities.	Depends on the ability and willingness of the individual.
Is there enough room for everyone to move around?	Teach player to push and turn holding the racket.	Balls, rackets, courts and scoring the same as non-disabled, but player is allowed two bounces of the ball.	Don't be afraid to ask what player can and can't do.	It is not compulsory to progress beyond the introductory level.
Consider the surface. Grass and carpet are difficult surfaces to push a wheelchair on, especially for higher-level disability.	Adapt the drills you do already with non-disabled players and give clear demonstrations.	Use regular equipment such as cones, lines, targets, etc.	Try not to speak down to a person in a chair.	
Work in zones to enable people of similar ability to be matched.	Consider chair movement and turns as part of game-play and tactics.	Can use a mitt and no racket if having problem holding racket and propelling chair at the same time.	Select team roles carefully to challenge but not frustrate.	
Consider safety in mixed groups of non-disabled players and wheelchair users, especially during warm-up periods, and use adapted equipment including orange and green balls and smaller courts.				

DEAF TENNIS

Space/ Environment	Tasks	Equipment/ Rules	People/ Communication	Speed of progress
Reduce noise levels where possible and be aware of indoor echo.	Demonstrate as much as possible, with talking kept to a minimum.	Provide written information for player to read after coaching sessions.	Find out how a person communicates, e.g. by lip-reading, through an interpreter, by sign language.	Depends on the ability and willingness of the individual.
Do not stand with light or the sun behind you, so player can see your face properly.	Position yourself so deaf people can see your face and lips. Be expressive and use body language.	Provide a pad and pen to write things down during a session if needs be.	Deafness is a hidden disability and it is easy to forget that a person might have additional communication requirements.	It is not compulsory to progress beyond the introductory level.
Need to consider a deaf person might not be able to hear a fire alarm.	Be patient and, if you are having difficulty communicating, try another approach e.g. rephrase, gesture, write down, draw.		It can be more difficult for a deaf person to socialise and develop confidence, due to communication difficulties.	
Remove sunglasses when communicating as players need to see your eyes.	Check engagement and understanding regularly.		Don't wear sunglasses, as deaf people need to be able to see your eyes.	
	If needs be, gain attention by tapping on shoulder, waving, or asking another person to get their attention.		Learn basic fingerspelling (or even British Sign Language if you can).	

VISUALLY IMPAIRED TENNIS

Space/ Environment	Tasks	Equipment/ Rules	People/ Communication	Speed of progress
Ensure court is free of obstacles and watch out for equipment stored at the back of the court.	Explain that the best way to coach a visually impaired person is to guide them through strokes. Hold head of racket with player holding handle.	Game is played with an audible foam ball (this 'sound ball' is larger than a regular ball and contains ball bearings for sound).	Visually impaired players can often integrate with non-disabled players, which allows groups to mix and socialise.	Depends on the ability and willingness of the individual.
Walk player around the courts, fire exits, toilet (not cubicle) and changing room areas.	Demonstrations may not work. Use lots and lots of explanation and guiding of the racket.	For visually impaired players the ball can bounce twice. For a totally blind person the ball can bounce three times.	Consider impact of having a visual impairment, e.g. cannot reach out and touch; cannot follow path of a moving object; dependent on external guidance.	It is not compulsory to progress beyond the introductory level.
Create a tactile court area, using floor tape and string, and cut out background noise.	Three basic skills to develop: spatial awareness, coordination and timing.	Think about court and ball colours e.g. dark floor and yellow ball work well, and vice versa.	Visually impaired players learn by listening and feeling.	
Need to guide players through the size of the court and height of the net.	Use sound awareness exercises e.g. ball rolling or throwing a ball against a wall and trying to catch it.	Use Mini Tennis net and rackets.		
Game can be played on a standard badminton court.	Visually impaired tennis requires more one-to-one individual coaching.			
Keep players who are waiting for a turn well away from the hitting area and court.	Tennis gets the heart going and produces a sweat (B1 players say there aren't many things they can do to exert lots of energy, but tennis does this).			

LEARNING DISABILITY TENNIS

Space/ Environment	Tasks	Equipment/ Rules	People/ Communication	Speed of progress
Allow extra space on courts for safety.	Break things down into simple tasks.	Could use larger sponge balls and Mini Tennis rackets.	See the ability in front of you, not the disability.	Depends on the ability and willingness of the individual.
Place players into positions on court.	Use plenty of visual demonstrations.	Use colourful equipment and visual aids.	Players need same skills as any other player.	It is not compulsory to progress beyond the introductory level.
Increase targets and decrease distances to make tasks easier.	Repeat steps of task frequently and allow more time for assimilation.		Need to set boundaries for behaviour.	
Adapt play to use zones, so everyone can join in.	Body language is important in getting messages across.		Use lots of positive praise and feedback.	
Consider evacuation procedures in an emergency.	Use trigger words to aid movement.			
Be aware of players' whereabouts at all times. Watch out for the wanderer.				

ADAPTING ACTIVITIES

When adapting an activity there are four considerations to make. Are there activities that are open that include and remain beneficial to all abilities; does the activity need to be modified to include all participants; can the activity be run with parallel groupings to ensure it is delivered at an appropriate level to all; or does the activity need to be specific and run separately for the group or individual? For example:

- **Open activity** – requires no alteration to the tennis session e.g. upper arm amputee joining in with existing activity and competition.
- **Modified activity** – uses adaptations and modifications to ensure session challenges and supports all abilities e.g. integrating wheelchair tennis player into existing activity and competition, and allowing wheelchair player two bounces.
- **Parallel activity** – use differentiation in sessions ensuring that players complete similar tasks but are grouped by ability/impairment e.g. grouping Special School Group by ability to ensure enjoyment of all.
- **Separate/discrete activity** – tennis sessions specific to disabled persons' requirements and rules for specific impairment groups e.g. Visually Impaired Tennis is played within service boxes with an audible ball and multiple bounces.

Discrete or separate activity is an acceptable form of inclusion where other forms of inclusion have been deemed inappropriate.



Playing

<i>Short Tennis</i>	14
<i>Ready to Go Modified Delivery Lesson Plans</i>	16
<i>Mix & Match Activity Cards</i>	53
<i>Cardio Tennis Activity Cards and Lesson Plans</i>	82
<i>Traditional Tennis</i>	140
<i>Ready to Go Traditional Delivery Lesson Plans</i>	142
<i>Mix & Match Activity Cards</i>	179

▶ Playing

SHORT TENNIS

Playing tennis is great fun and by using modified equipment and space, everyone can achieve, whether they have played before or not.

Short Tennis is a great way for people of all ages and abilities to enjoy playing tennis. It's just like the real thing, but with smaller courts, nets, rackets and softer balls making it easier and more fun to play. Whether you are a complete beginner or just want to play with your mates, Short Tennis is for you. Another great benefit of Short Tennis is that you don't need a tennis court – it can be played in a sports hall, on badminton courts, any large indoor space, or even on a free strip of car park (keep your eyes out for moving cars!). Short Tennis will allow more young people to participate at a level that is appropriate for them, which gives them more chance of success, making them want to play again.

Short Tennis could provide the perfect format to start off your Tennis Satellite Club and if you can gain access to a suitable indoor space, it will also keep the participants attending during the winter months!

Getting started with Short Tennis:

- You can set up Short Tennis courts using badminton courts or regular tennis courts, for more support take a look at the section on 'how to set up Mini Tennis courts' in the School Games Tennis Toolkit CD-ROM.
- You can also set up your own courts using Mini/ Short Tennis nets or barrier tape for the nets and mark out the lines with masking tape/throw down lines.
- If you can, use 21" rackets and 8cm foam balls (inside) or low compression balls (outside).

How do you score a Short Tennis match?

Two of the best options are:

1. First to 10 points, like a standard tennis match tie-break, with each player having two service points each, two clear points needed to win. The nominated person serves for the first point, it then alternates every two points; when serving, players should stand behind the baseline; the serve can be hit underarm or overarm and the ball must not bounce before being hit; serves should be hit diagonally, landing in the diagonally opposite service box. Don't forget to change ends every 6 points.
2. Short sets or full sets, first to four games and six games respectively, with full service games and regular tennis scoring. Alternatively to add a bit of drama, all service games can be decided by a "sudden death" point if they go to deuce (receiver chooses which side). This shortens the time required to complete matches.



In both of the scoring options you can set the rules about the number of serves you allow, i.e. Allow two serving chances like regular tennis or make it harder with only one serve allowed.

Variations:

- You can set your own scoring to fit in with the number of players and courts you have, so a match can be 'first to whatever you want really!'
- Play doubles matches.
- Play Timed Tennis Matches – Players play for a set period of time, until the whistle blows. The length of matches depends on time available and amount of entries e.g. 10 minute matches, with a final deciding point if there is a draw on the whistle. Timed matches can be ideal for running competitions as you can plan exactly how long matches will last and therefore the overall time your competition will take. There are a range of example timings and formats in the School Games Tennis Toolkit CD-ROM included in the toolkit.

'Ready to go' lesson plans

A series of lesson plans providing the structure and content for 6 lessons, using Short Tennis as a modified method of delivery in a sports hall or on tennis courts.

'Mix and match' activity cards

You can mix and match these activity cards to develop your own lesson plans and to help provide some additional ideas for activities. Most of the activities included on the 'mix and match' activity cards can be adapted to cater for Short Tennis or traditional tennis delivery.



Design Your Club



- Once you have introduced the concept of Short Tennis and been using the activities in the toolkit, you can get the participants selecting their own activities, setting their own goals and progressing at the appropriate rate. Some of the group may prefer to keep playing Short Tennis, however, others may wish to progress to low compression balls on a modified tennis court or even the full court.
- Get the participants working in pairs or small groups to plan and deliver a session, perhaps giving each group a theme or particular activity card to work on.

Ready to Go

MODIFIED DELIVERY LESSONS PLANS: 1-6

- **Lesson One** 17
Game Situation Topic: Both Back
Tactic Topic: Over and In
Skill Topic: Forehand

- **Lesson Two** 23
Game Situation Topic: Both Back
Tactic Topic: Over and In
Skill Topic: Backhand

- **Lesson Three** 30
Game Situation Topic: When Serving and When Returning
Tactic Topic: Over and In
Skill Topic: Serve and Return

- **Lesson Four** 36
Game Situation Topic: When Approaching or at the Net
Tactic Topic: Over and In
Skill Topic: Volley

- **Lesson Five** 41
Game Situation Topic: Linking Shots to Play the Game
Tactic Topic: Move the Opponent
Skill Topic: Maintaining a Good Court Position

- **Lesson Six** 47
Game Situation Topic: Competition



WARM-UP ACTIVITY

Widths

L1

- Pupils jog from tram to tram with arms circling, sidestepping, crossover steps, etc.
- Pupil to split step at each end.
- Teacher to reinforce running technique and introduce split step to receive the ball, staying balanced while turning with small adjusting steps.

QUALITY POINTS

- *Keep your balance by leaning forwards slightly when jogging backwards.*
- *Do a split step at each end.*

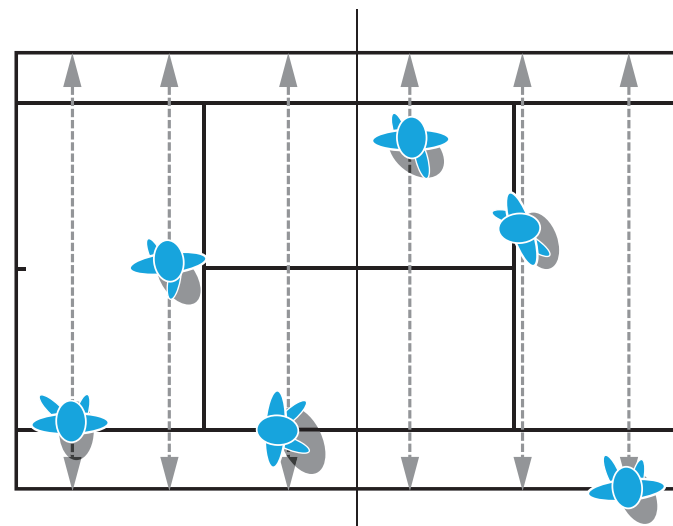

WARM-UP ACTIVITY

Cone Ladders

L1

- Set up a ladder for each group of 3/4 players. A ladder has 10 cones or lines in a row 30cm apart.
- Position players at the start of a ladder and demonstrate.
- Organise players into groups to start at the beginning of each ladder.
- Player 1 moves through the ladder by stepping over the cones/lines in various footwork patterns and split steps at the end of the ladder. Player 1 turns and runs back to the start. Player 2 starts when Player 1 does the split step.

QUALITY POINTS

- *Coordinate arms and legs, moving at the same pace.*
- *Keep the body upright.*
- *Adjust stride length for different distances.*

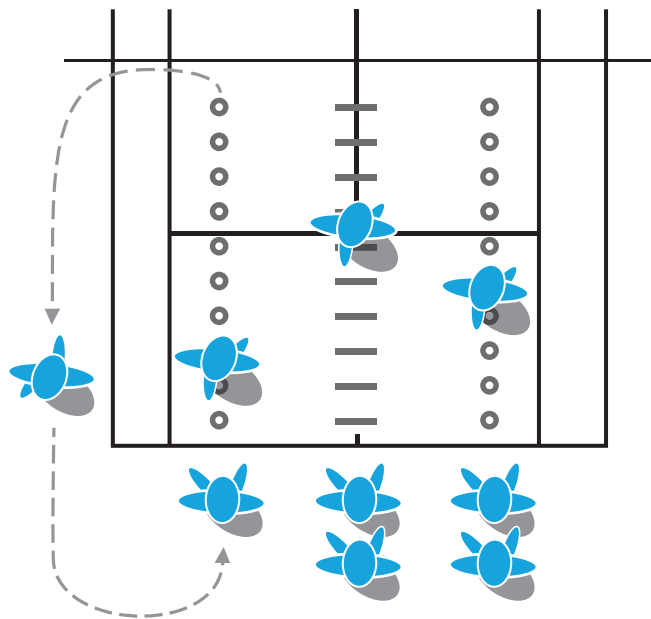

MAIN THEME

Floor Tennis

L1

ORGANISATION

- Equipment: balls, rackets, cones.
- Define the playing area.
- Position players at the side of the area and demonstrate.
- Highlight safe use of rackets.
- Organise players into twos and two spaces.

ACTIVITY

- With one pupil at each end of playing area, pupils push ball back and forth to each other to develop a rally.
 1. Stop ball before pushing back.
 2. Push back without stopping.
- Start in ready position.
- Turn sideways for forehand and backhand.

EASIER

- Use hands to stop the ball then push it back.
- Roll the ball to each other.

HARDER

- In a rally both players push alternate forehands and backhands.
- Stop the ball with a foot then push it with a racket.
- Set the cones wider for more movement.
- Set the cones narrower for accuracy.

QUALITY POINTS

- *Put the favourite hand at the bottom of the grip.*
- *Get ready between pushes.*
- *Bend at the knees and waist to get low.*
- *Contact the ball out in front.*
- *Push the ball, don't swing at it.*

COMPETITION

- In 2s rally through cones:
 1. Count how many pushes in one rally and remember best score. Compete against other pairs.
 2. For every rally of six shots in a row win a cone. Collect cones for two minutes.
 3. Race to do a rally of 10 in a row.
 4. Try to score a goal.

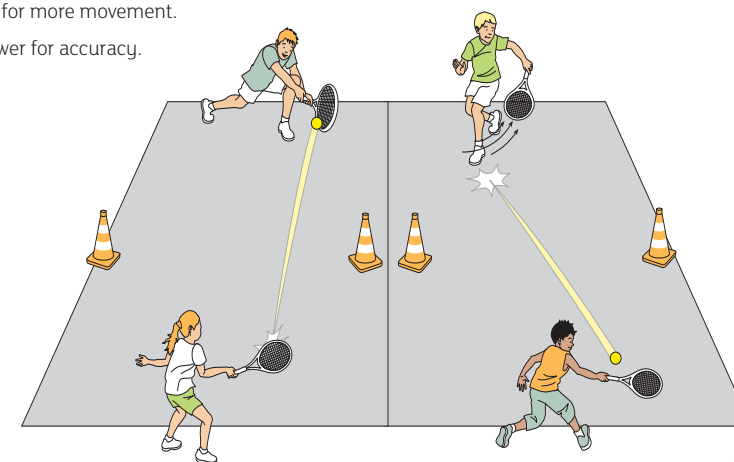

MAIN THEME

Racket Target Games

L1

ORGANISATION

- Pupils place rackets on the floor either side of the net as per diagram.
- Players take a large step back from their racket.

ACTIVITY

- Pupils throw and catch over the net aiming for the ball to bounce on the other's racket.
- Teacher could introduce tennis scoring.

EASIER

- Use a larger target area.
- Players to be closer together.

HARDER

- Use a smaller target area.
- Move target further back.

COMPETITION

- Players score points each time they hit their opponent's racket.

QUALITY POINTS

- *Turn sideways for underarm feed.*
- *Non dominant side towards the net.*
- *Ball must arc over the net when released from the hand.*

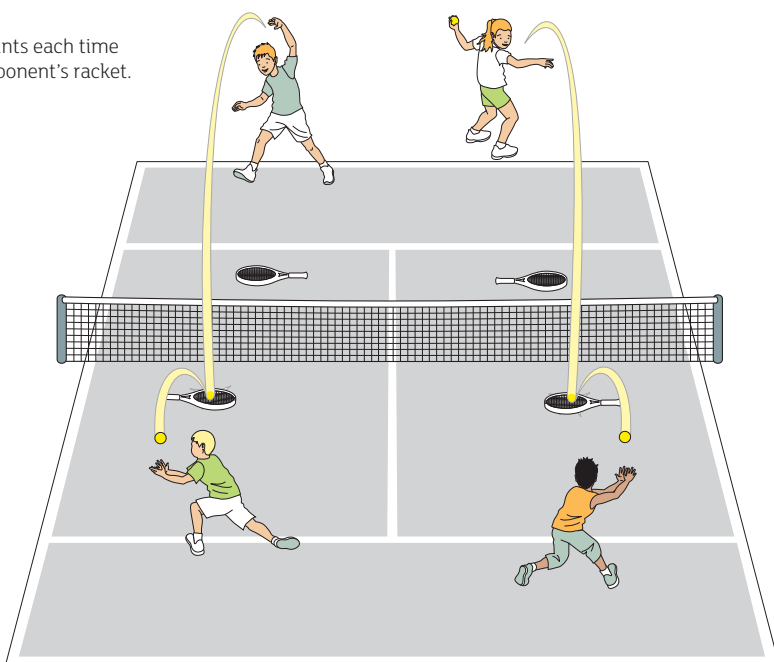

MAIN THEME

Catch Tennis

L1

Teacher to demonstrate Forehand.

ORGANISATION

- Two players as per diagram.
- Three players hitter, feeder and catcher.
- Four players hitter, feeder, catcher and collector.
- Players rotate after x goes.

ACTIVITY

- One pupil feeds under arm to partner who hits a forehand back.
- Feeder to catch.
- X number and swap.

EASIER

- Hitter could start with racket at contact point.

HARDER

- Hitter to aim for a specific target.

COMPETITION

Make out a small court area with a net or similar. In two players rally with a ball in a defined court area. Each rally starts with an overarm throw and if the ball goes out of the area the rally stops.

1. Count how many catches in a row. Remember best score. Compete against other pairs.
2. Race to do 10 catches in a row.

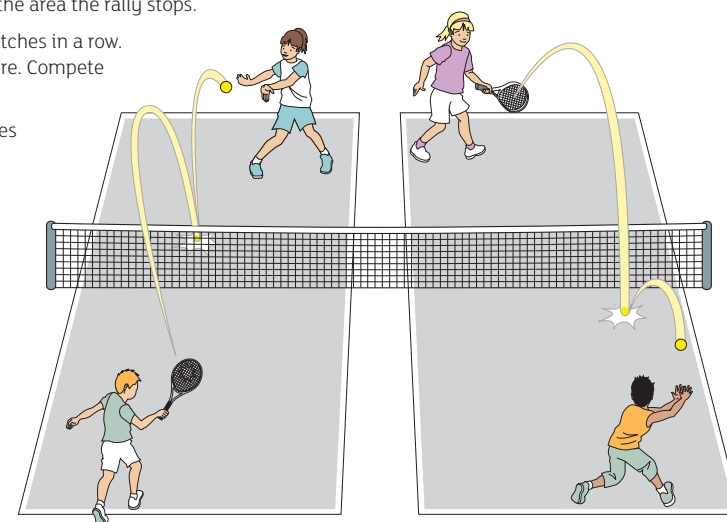

QUALITY POINTS

- **For the Feeder:**
 - *Throw underarm with a smooth arm swing at the side of the body.*
 - *Recover after the throw and get ready for the next catch.*
 - *Get ready for the catch with hands in front, palms forward and fingers down.*
 - *Get behind the bounce of the ball.*
 - *Control the catch using soft hands.*
- **For the Hitter:**
 - *Ready position.*
 - *Turn sideways.*
 - *Low to high swing.*
 - *Racket back down before the ball has bounced.*
 - *Contact to the side, in front and at waist height.*

COMPETITION

One Hit Doubles

L1

ORGANISATION

- Divide players into two teams and then, within each team, into pairs.
- Match up Team 1 pairs against Team 2 pairs on a court for each match.

ACTIVITY

- Players in pairs play points to seven hitting alternately against an opposing pair.
- The first match to finish shouts STOP and all matches must stop instantly, not finishing the point.
- The pairs who have won or are winning at the time of stopping record two points for their team. If a match is drawn they both record a point.
- After Round 1 the pairs of Team 1 move up the courts, and Team 2 stay and Round 2 starts.
- Play two, three or four rounds depending on time.

AT THE END

- Declare the winning teams.

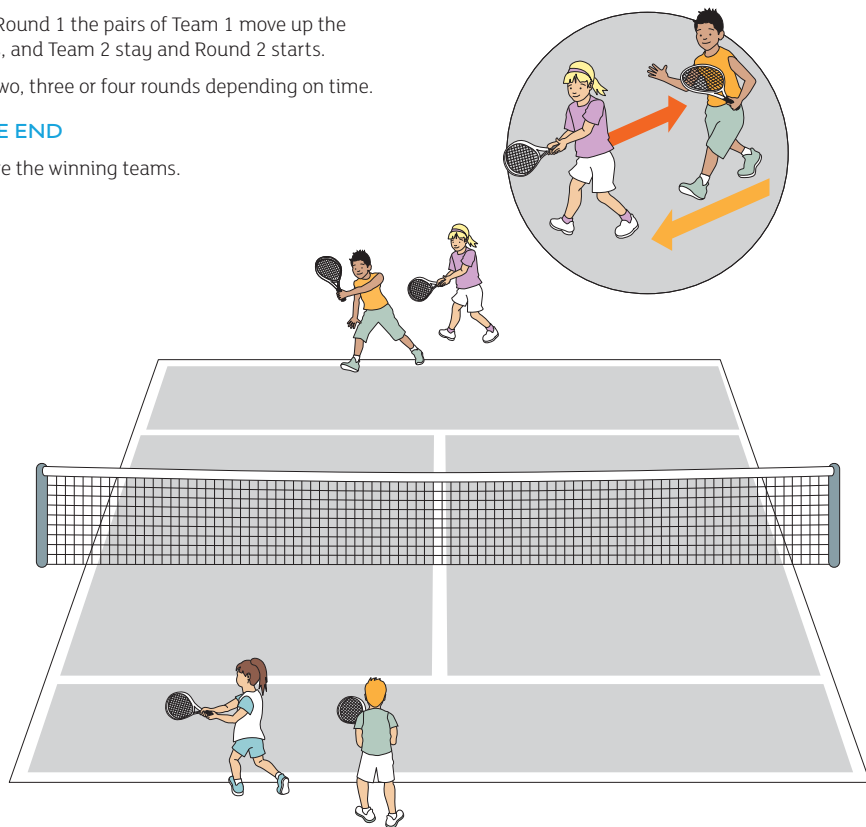

WARM-UP ACTIVITY

Gr8

L2

- Players run around two cones placed on the ground in a figure of 8.
- Pupils to face forward at all times, stay low with small adjusting steps.

QUALITY POINTS

- *Stay low and use your arms to help you.*
- *Keep on the balls of your feet.*

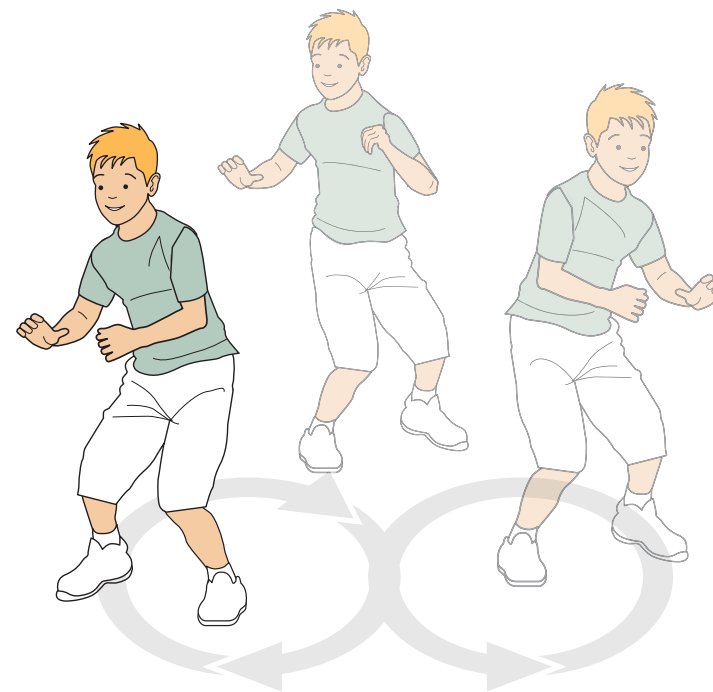

WARM-UP ACTIVITY

Target Tennis

L2

- Players place several cones about 1m from either side of the net.
- Players rally aiming to hit the others cones.
- They collect the cones they hit.

QUALITY POINTS

- *Balanced alert ready position.*
- *Angle the racket face to the target.*
- *Increase the path of the push to get the ball to go further.*

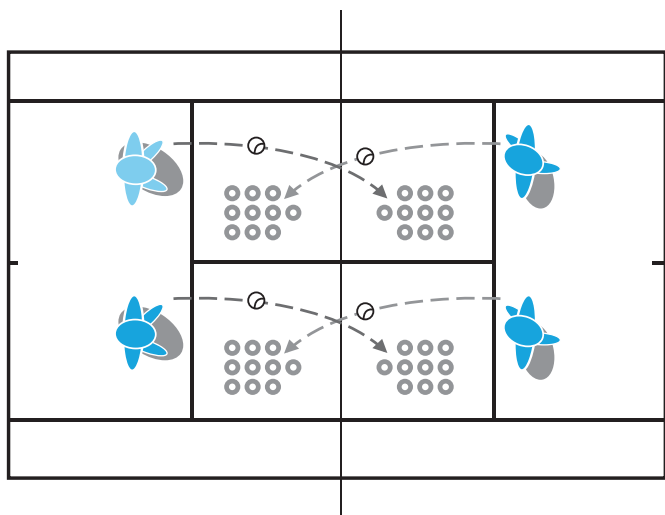

MAIN THEME

Catch Tennis

L2

Teacher to demonstrate Backhand.

ORGANISATION

- Two players as per diagram.
- Three players hitter, feeder and catcher.
- Four players hitter, feeder, catcher and collector.
- Players rotate after x goes.

ACTIVITY

- One pupil feeds under arm to partner who hits a backhand back.
- Feeder to catch.
- X number and swap.

EASIER

- Hitter could start with racket at contact point.

HARDER

- Hitter to aim for a specific target.

COMPETITION

Make out a small court area with a net or similar. In twos players rally with a ball in a defined court area. Each rally starts with an overarm throw and if the ball goes out of the area the rally stops.

1. Count how many catches in a row. Remember best score. Compete against other pairs.
2. Race to do 10 catches in a row.

QUALITY POINTS

- *Throw underarm with a smooth arm swing at the side of the body.*
- *Recover after the throw and get ready for the next catch.*
- *Get ready for the catch with hands in front, palms forward and fingers down.*
- *Get behind the bounce of the ball.*
- *Control the catch using soft hands.*
- *Most players will find it easier using both hands, with dominant hand at the base of the grip.*

Continued...

MAIN THEME

Catch Tennis

(continued)

L2

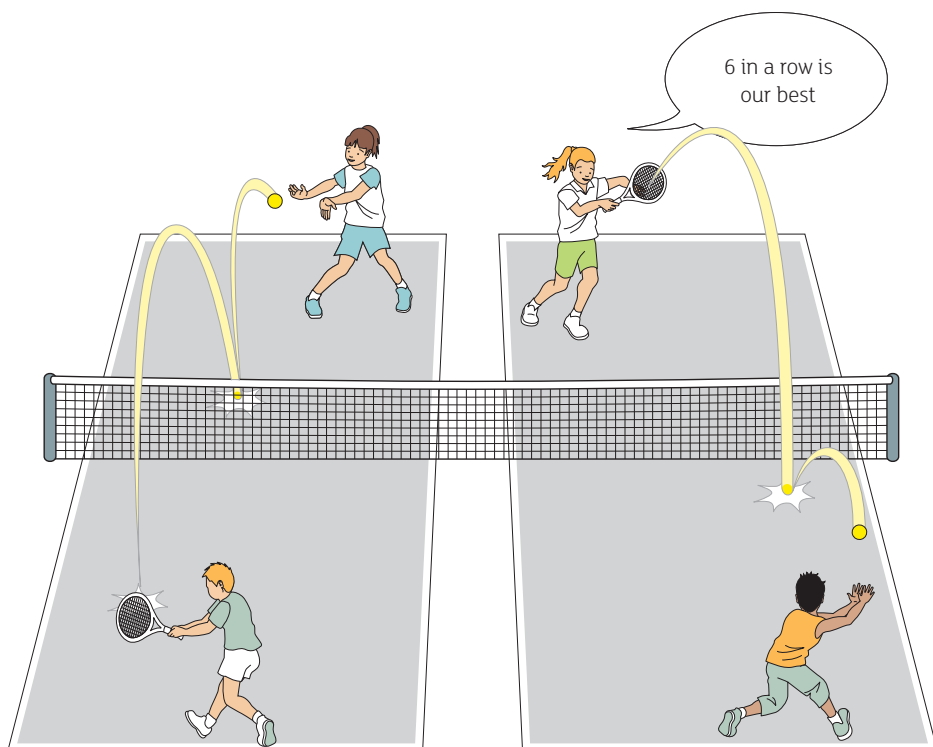

MAIN THEME

Step Back Rallies

L2

ORGANISATION

- Equipment: rackets, ball, throw-down lines.
- Define the court area.
- Position players at the side of the court and demonstrate.
- Highlight the need to stop a shot if an other player is near.
- Organise players into twos on courts.

ACTIVITY

- Players start close to the net hitting forehands and backhands.
- After each successful hit they take a step backwards until they reach the baseline.

EASIER

- One player hits and the other throws and catches.
- Catch tennis rally.
- Floor tennis rally under the net.

HARDER

- Start each rally with an overarm serve.
- Players have to hit alternate forehands and backhands.

COMPETITION

- **Cooperative:** Race other pairs to see who can get further back in a set time.
- **Competitive:** Players create a baseline five rackets lengths from the net on each side and play points. After every three points the player that is loosing can say 'longer' or 'shorter' and the court must be made one racket longer or one racket shorter for the next three points.

QUALITY POINTS

- *Get the racket back early by turning the body.*
- *Increase the length of the stroke for longer shots.*
- *Contact the ball out in front.*
- *Recover and get ready between shots.*
- *Point strings in the direction the ball is intended to go.*
- *Turn sideways for forehands and backhands.*

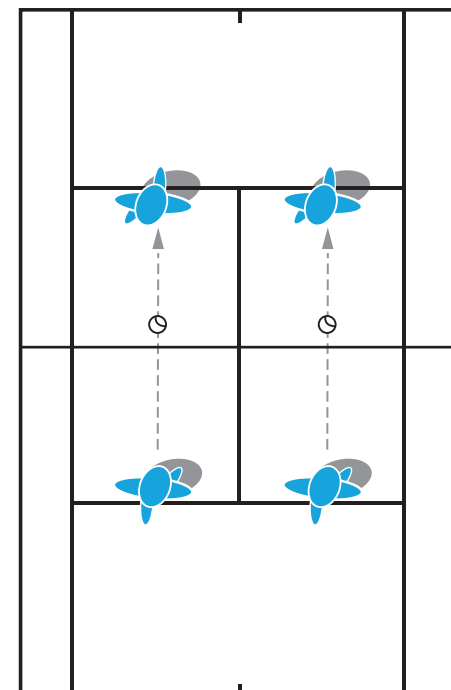

MAIN THEME

Rally & Recover

L2

ORGANISATION

- Equipment: rackets, balls. Define the court and the half court tracks.
- Position the players at side of the court and demonstrate.
- Highlight the need to stop if another player is near when hitting, especially in the middle of the court.
- Organise players into twos on half court tracks.

ACTIVITY

- Players take turns to feed the ball in and to rally as long as possible.
- Players focus on recovering with at least two steps.

EASIER

- Only one player does the two step recovery then change roles after ten hits.
- Player 1 throws and Player 2 hits and recovers.
- Play in a shorter court.

HARDER

- Use specific movement patterns for recovery.
- In cross court rallies use the outside shot i.e. forehand on the backhand side and backhand on the forehand side.

QUALITY POINTS

- *Balanced, alert ready position.*
- *Complete the shot before recovering.*
- *Keep watching the ball during recovery.*
- *Small adjusting steps.*
- *Point strings in the direction the ball is intended to go.*

COMPETITION

- **Cooperative:** In fours. Two players rally, both doing a two step recovery to the middle. Two players are judges. A successful rally of six in a row wins a cone. Players win additional cones each time they hit a backhand. After one minute players and judges change roles. Compete against the other pairs.
- **Competitive:** In fours. Two players rally. If either player does not do a two step recovery the other player wins a cone. Two players are judges. After a set time the player with the most cones wins. Players win additional cones each time they hit a backhand.

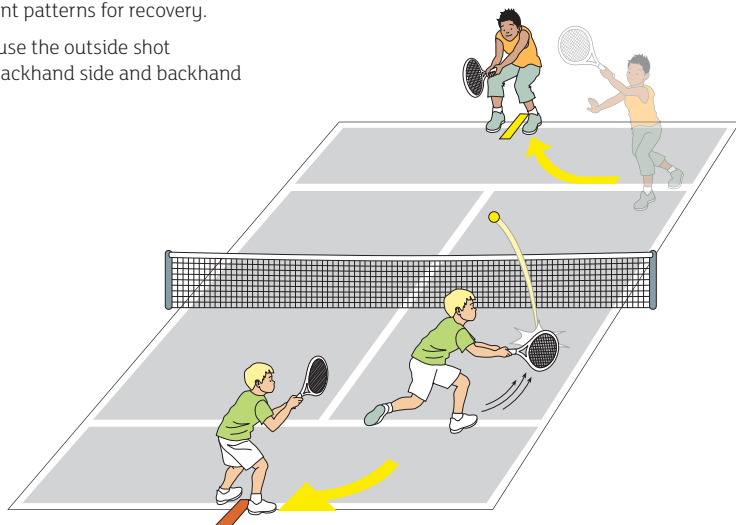

COMPETITION

Team Cones

L2

ORGANISATION

- Have two sets of coloured cones.
- Divide players into two teams: can be same or different numbers.

ACTIVITY

- Players to play singles matches on a full or half court.
- When they win a match they win a cone for their team.
- The team with the most cones at the end is the winning team.
- Line each team up behind one team cone.
- The first player in each line goes to court one, next two players on Court 2, etc.

- Each match is to four points.
- Players can start the point with either a throw or an underarm/overarm serve.
- At the end of each match the winning player puts a cone onto the team cone stack and they both join the back of their team line.
- The next two players go to the free court.
- If the teams have different numbers the player rotation will happen naturally.
- If they have the same number, organise players so they have different matches.

AT THE END

- At the end, count up the team cones and declare the winning team.

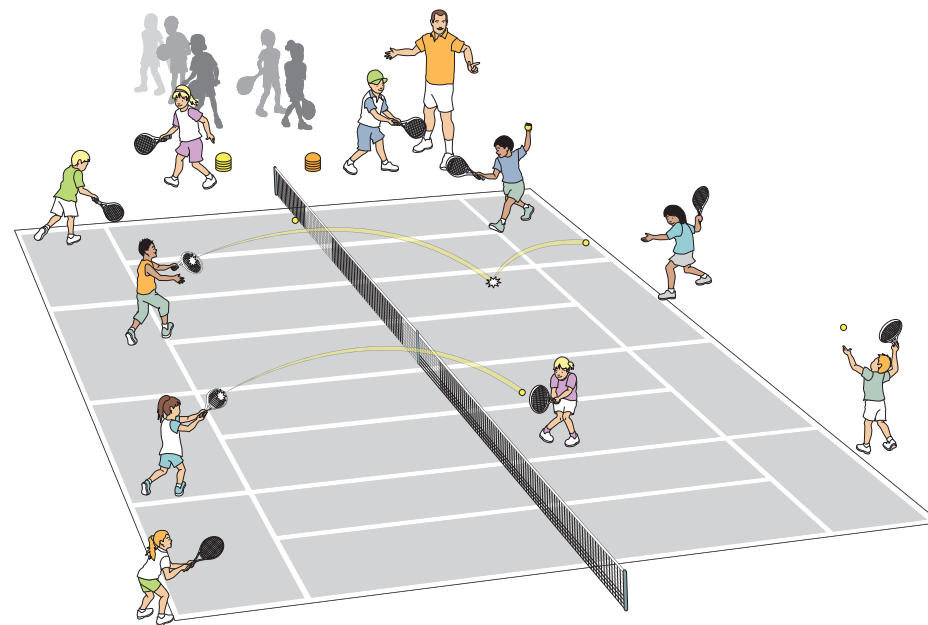

WARM-UP ACTIVITY

Racing Rallies

L3

- Facing each other, players sidestep lengths of the half court bouncing, kicking or throwing the ball to each other.

QUALITY POINTS

- Teams rally on half/third of a court in service boxes. At one end, just behind the baseline.
- You can have more than two in a team by rotating the players between rallies or shots.
- After three minutes, if there is no winner then the game stops and the team with least balls in their hoop wins.
- Stay low.
- Take small quick steps.

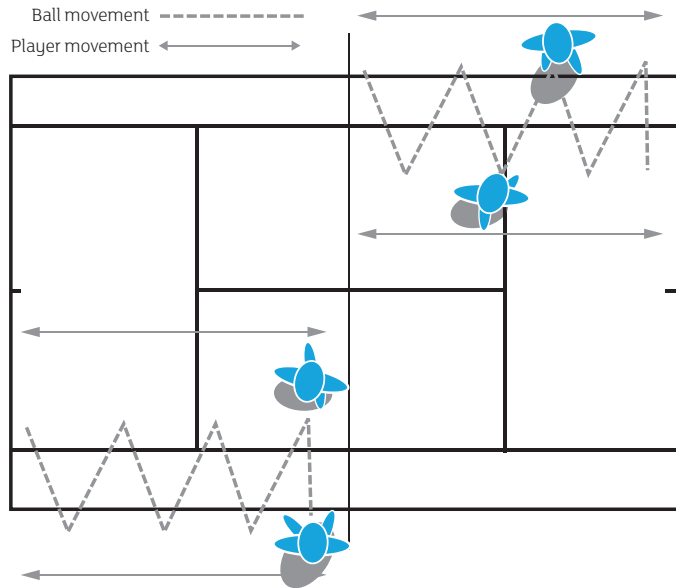

WARM-UP ACTIVITY

Throw and Go

L3

- Players line up behind a marker and use a variety of throws to pass the ball to the player in front.
- The thrower then runs to the end of the receivers' line.
- Using both hands throw forehand side, backhand side, overhead throw.
- Stop and balance before throwing, keep head and shoulders still, follow through with arms in front.

QUALITY POINTS

- Keep your head up to watch your partner as well as the ball.
- Have a balanced base and light footwork.

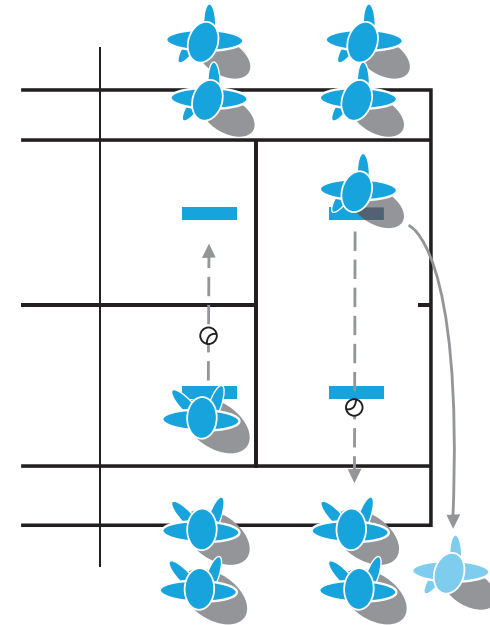

MAIN THEME

Target Throw

L3

ORGANISATION

- Equipment: balls, ropes, hoops, throw-down lines or cones.
- Set up two targets on each court, one long, one short, in each service box at one end of the court.
- Position players at the side of the court and demonstrate.
- Organise players into twos.

ACTIVITY

Player 1 has four balls and sets up behind the service line to throw overarm alternately at the short and long targets in the diagonally opposite service box. Player 2 watches the ball land and calls in or out, and then collects the ball. After four throws players change sides. After another four throws players change ends.

EASIER

- Throw overarm from nearer the net.
- Throw underarm from nearer the net.

HARDER

- Throw from further back.
- Make the targets smaller.
- Aim to forehand or backhand of partner.

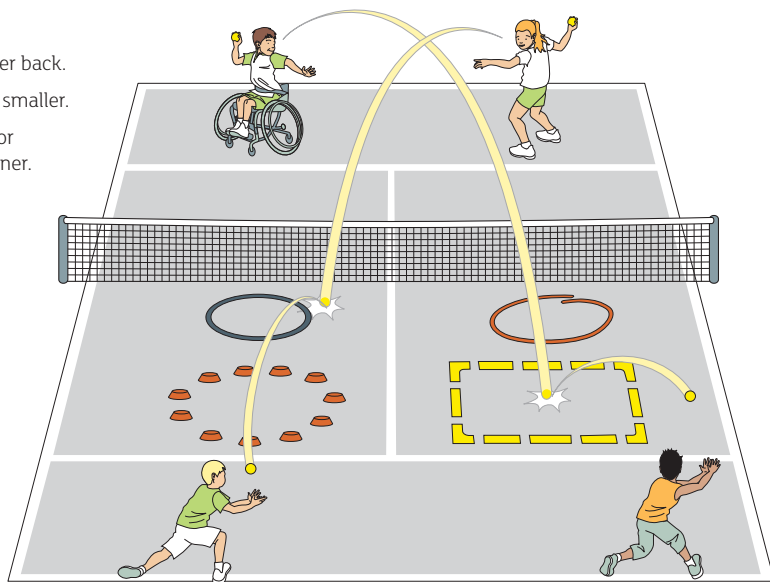

QUALITY POINTS

- Set up sideways with feet behind the line.
- Get a good ready to throw position.
- Line shoulders up with where the ball should go.
- Aim upwards and forwards.
- Finish in a balanced position.
- Aim upwards and forwards with non-dominant arm.
- Elbow of throwing arm pointing at back wall (Nike tick position).
- Ball must be thrown up.
- Finish in a balanced position.

MAIN THEME

Overarm Server

L3

Teacher to demonstrate Serve and Return.

ORGANISATION

- Equipment: rackets, balls, throw-down lines. Define the service area.
- Position players at the side of the court and demonstrate one activity at a time.
- Highlight the need for a space behind when serving.
- Players can play individually or in twos, always in a suitable space and behind a line.

ACTIVITY

- Players go through the progressions of the serve:
 1. Balanced starting position, racket in one hand and ball in another.
 2. Hands go down together – up together.
 3. Racket stops in pre throw position.
 4. Place ball in air and catch with non dominant arm.
 5. Place ball in the air and hit overhead. Players hit five serves and swap.

EASIER

- Players can serve underarm.
- Players can be closer to the net.

HARDER

- Serve to a specific target area in the box.

QUALITY POINTS

- Start balanced and sideways behind the line.
- Start with the ball and racket together pointing to the service area.
- Use a slow smooth arm action for placing the ball up.
- Place the ball a little higher than the racket can reach.
- Use an action like an overarm throw for hitting the ball.

COMPETITION

1. 'I serve you catch' - in twos players serve to each other so that the partner catches it with the racket and hand after the bounce. Players score a point for every successful catch. They compete against other pairs in a certain time.
2. In twos players serve alternately from a start line. Every time a player serves successfully they move the line back a racket length. Each player tries to get further back than their partner in a certain time.

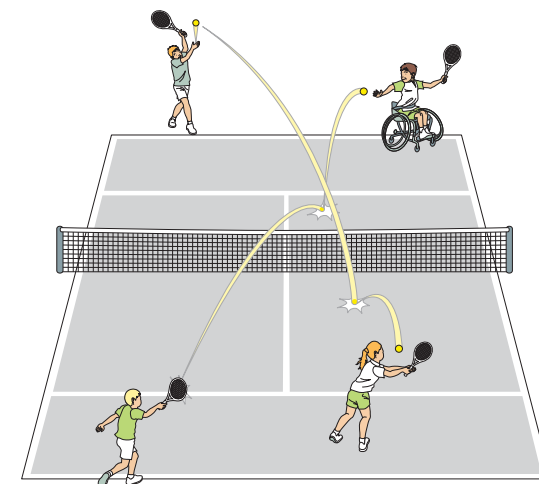

MAIN THEME

Return the Serve

L3

ORGANISATION

- Equipment: rackets, balls throw-down lines.
- Define the court area and diagonal service area.
- Organise players into twos, one at each end.
- Position players at the side of the court and demonstrate.
- Highlight the need to be in a space before serving.

ACTIVITY

- In pairs Player 1 serves overarm or underarm from behind the service line.
- Player 2 starts in a balanced ready position and split steps when the server hits the ball.
 1. Player 2 calls out forehand or backhand as soon as possible and stops the ball on their racket.
 2. Player 2 calls out forehand or backhand and returns the ball.
- Server serves / player returns / server hits next shot / returner catches.
- Returner then serves.

EASIER

- Player 2 taps the ball up before hitting the return.
- Player 1 throws overarms and Player 2 hits the return.

HARDER

- Player 1 catches the ball, after the return, with the racket and hand.
- Player 2 directs the return to a target area of the court.

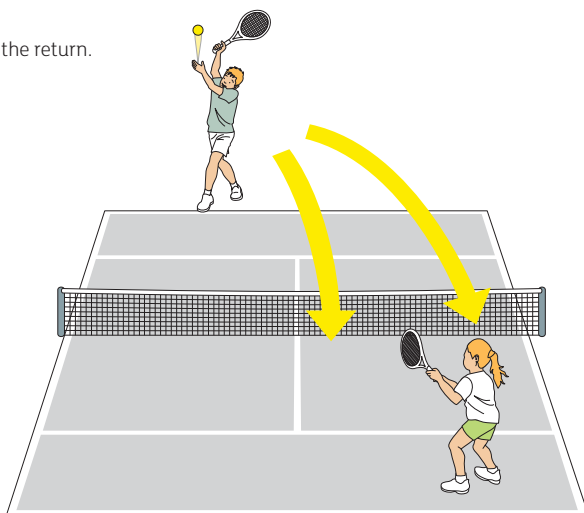

QUALITY POINTS

- *A balanced and relaxed ready position.*
- *Watch the direction and height of the ball.*
- *Turn the upper body quickly towards the ball.*
- *Hit the ball out in front.*
- *Recover to the centre of the court after the return.*
- *Contact in front and point strings in the direction they want the ball to go.*
- *Shorter swing on faster balls.*

COMPETITION

- **Cooperative:** 'I serve you return' - in twos players cooperate to serve and return the serve so that they are both in the corrupt area. Players win a cone for each successive serve and return. Compete against other pairs in a set time.
- **Competitive:** In twos players play points against each other. They serve alternate points. There must be a successful serve and return before the competitive point can start.

COMPETITION

Scoring a Tie Break

L3

ORGANISATION

- For players who can rally and understand how to win a point. Use Winning a Point.
- Equipment: rackets, balls, cones.
- Define the court area for matches. At the side of the court put a row of seven cones for each player. At each end of the court behind the servers put a red cone on the right side and a another colour cone on the left side.
- Position players at the side of the court and demonstrate the order for serving.
- Highlight the safe use of rackets.
- Organise players into fours. Two players, and two observers on each court.

ACTIVITY

- Two players play points. Player 1 serves first from the Right side for one point. Player 2 then serves one point from the Left side and then 1 point from the Right side. Player 1 then serves from the Left then Right and so on.
- Observer 1 is scorer and watches, and for each point puts a ball on the winner's row of cones, and calls the score. Observer 2 watches the serving order and points to the correct server and the correct side. Stop at the end of each point and agree the score before the next point.

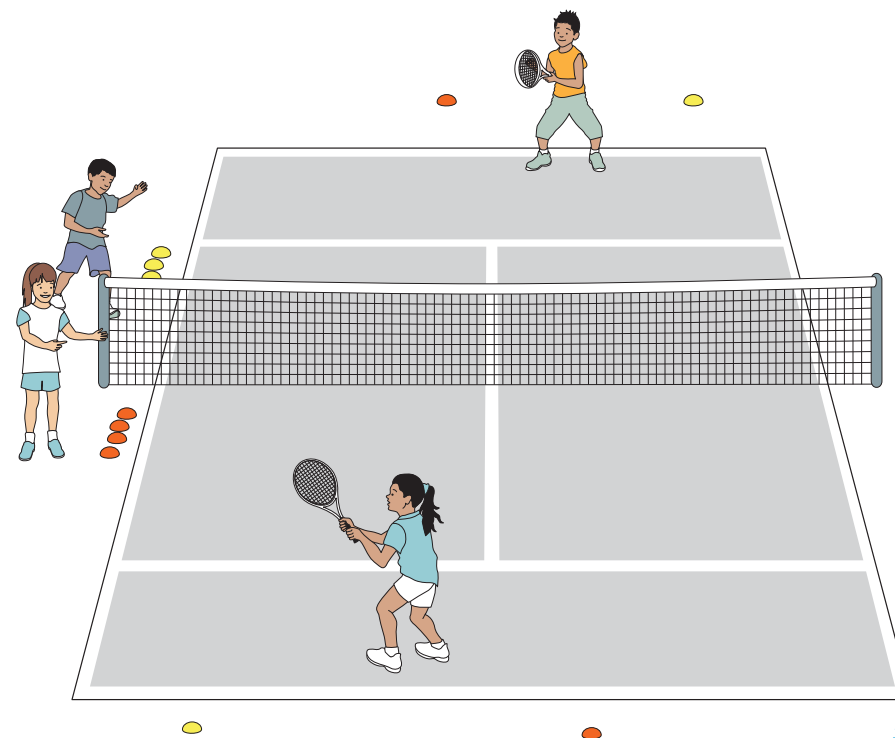

WARM-UP ACTIVITY

High, Middle and Low



- Players move sideways around the court facing each other throwing a ball...
 1. Above the head (High)
 2. At waist height (Middle) and
 3. Roll along the floor (Low).
- Players continue in sequence changing when teacher calls out.
- Players change body height to receive the ball, staying balanced while turning with small adjusting steps.

QUALITY POINTS

- *Keep your head up to watch your partner as well as the ball.*
- *Have a balanced base and light footwork.*

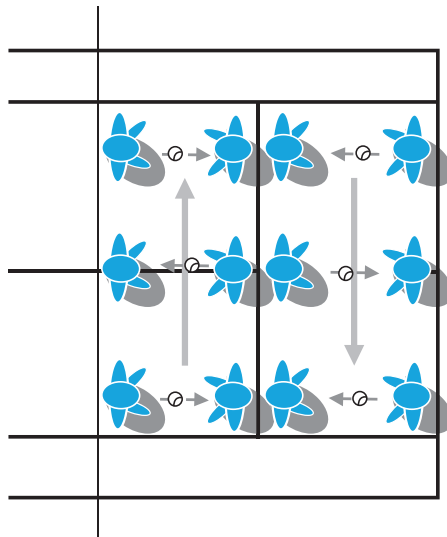

WARM-UP ACTIVITY

Catch me if you can



- In pairs players face the same direction with Player 1 behind Player 2.
- Player 1 sprints and Player 2 tries to catch him.
- Players swap.
- Stay low, head still, use arms, maximum stride length as soon as possible.

QUALITY POINTS

- *Concentrate on accelerating over your first 3 steps. Get to your maximum stride length as soon as possible.*
- *Walk back to the start to recover.*

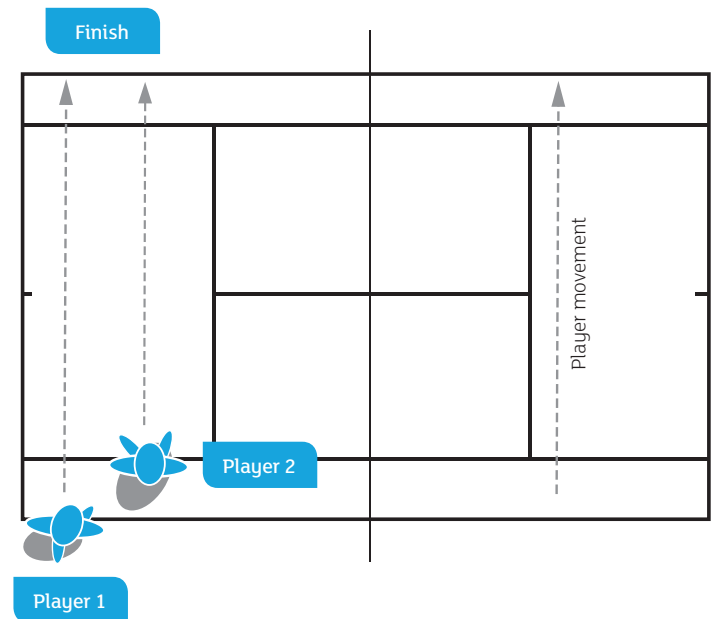

MAIN THEME

React 'n Volley

L4

Teacher to demonstrate Volley.

ORGANISATION

- Equipment: rackets, ball.
- Define the court area and the volley position (from the net racket, stretch and step back).
- Position players and demonstrate.
- Highlight safe use of rackets and balls.
- Organise players into twos, one at each end.

ACTIVITY

- In pairs Player 1 feeds the ball to Player 2, forehand side.
- Player 2 starts with racket out at the side and in front Player 2 "pushes" the ball back to Player 1 who catches (repeat three times).
- Player 1 then feeds to the backhand side (repeat three times).
- Players swap.
- Players then start from ready position and feeder can feed either side.
- Volleyer to return to ready position after each volley.

EASIER

- Player 2 catches the ball with the hand.
- Player 2 bats the ball with a hand with the palm forward.
- Start with the racket out at the side ready to volley.

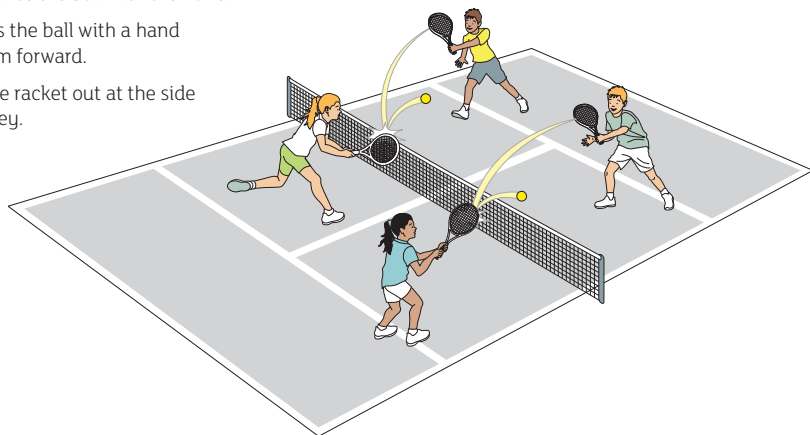

QUALITY POINTS

- *Balanced ready position.*
- *Short block action.*
- *Point strings to target area.*

HARDER

- Player 2 does a split step just before Player 1 throws the ball.
- Player 1 throws the ball more quickly to help Player 2 react quickly.
- Player 1 hits the ball to Player 2.

COMPETITION

- **Cooperative:** In fours in a 2v2 race. Pair one do 'throw, volley and catch' as many times as possible while Pair 2 run all the way around the court out at a time. Change roles. The pair with the highest number of catches wins.

MAIN THEME

Up 'n Volley

L4

ORGANISATION

- Equipment: rackets, balls.
- Define the court area and the volley position in relation to the net.
- Position players and demonstrate.
- Highlight safe use of rackets and balls.
- Organise players into twos.

ACTIVITY

- In pairs players start on the service line.
- Player 2 starts to move forward and Player 1 calls out stop and feeds the ball.
- Player 2 split steps in a ready position and moves forward to volley.
- After five throws players change roles.

EASIER

- Players start at the net.
- Feeder gives only forehand or only backhand volleys.

QUALITY POINTS

- *Split step and get ready to move.*
- *Hit from a good balanced position, stepping forwards to meet the ball.*
- *Keep the racket head higher than the hand on contact.*
- *Keep the action short.*

HARDER

- Players rally and move in to volley when the ball drops short.

COMPETITION

- In pairs players feed the ball in from the baseline and play out the point. They approach on a short ball and score extra points for a winning volley.

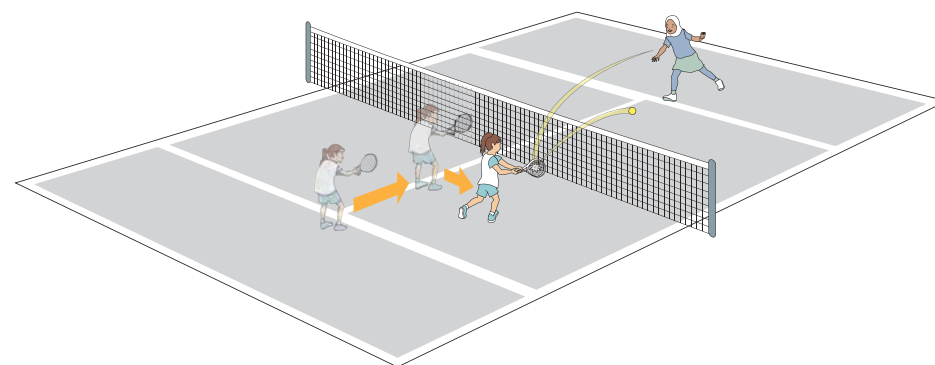

COMPETITION Tag Team Tennis

L4

ORGANISATION

- Put players in twos - it's also possible to have more than two in a team, with more rotations of players.
- Match up opposing teams for matches.

ACTIVITY

- Each match is a tie break (this can be flexible, dependent on time available (start with overarm or underarm serve).
- The match starts between two players (one from each team) with the others on the side of the court scoring and encouraging the players.
- After every four points (flexible), players are 'tagged' (replaced) by their team mate and play continues.
- The scoring is continuous. An additional two points are scored every time a point is won with a volley.

AT THE END

- Declare the winning teams.

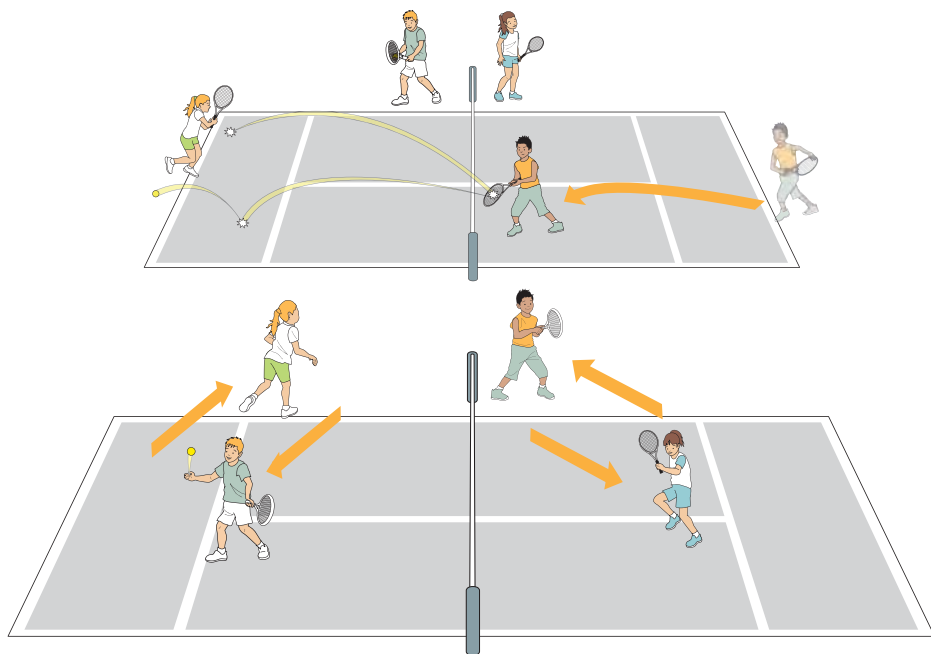

WARM-UP ACTIVITY Shadow Shots

L5

- Players jog on the spot and teacher calls out forehand, backhand, serve or volley.
- Players split step and shadow the shot called out.

QUALITY POINTS

- *Players to be balanced.*
- *Shadow a controlled shot.*

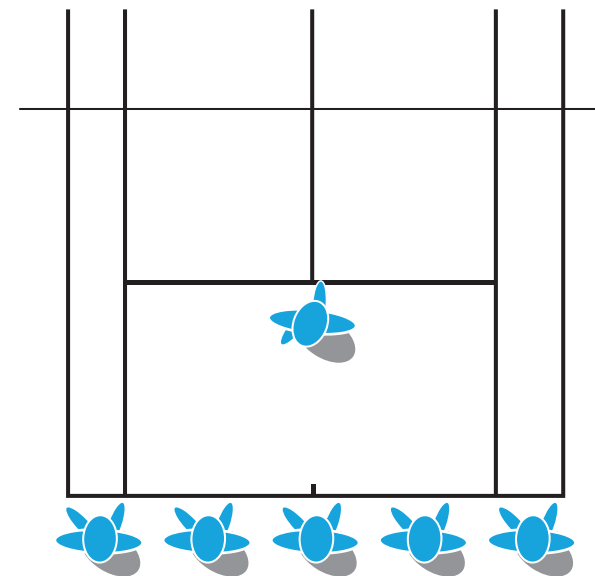

MAIN THEME

Homebase

L5

- In pairs players play Catch Tennis and have to throw the ball back before recovering to "Homebase".
- Players should throw the ball to spaces to make the opponent move.
- Teacher could introduce underarm feeds if the ball has bounced (a groundstroke) or over arm feeds if the ball is caught before it bounces (a volley).
- Stop and balance before throwing, keep head and shoulders still, follow through with arms in front.

QUALITY POINTS

- *Get ready, balanced, feet apart, knees bent and ready to move.*
- *Recover quickly.*
- *Look at the ball during recovery.*

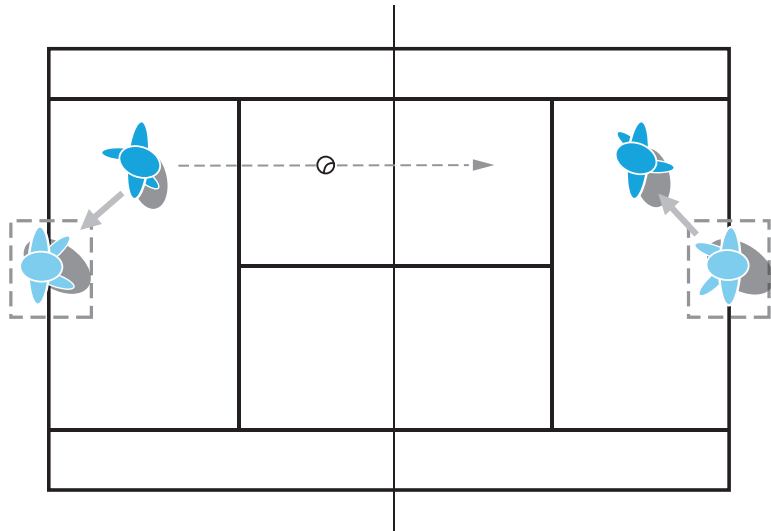

MAIN THEME

Radar

L5

ORGANISATION

- Equipment: balls, rackets, throw-down lines.
- Define each court area. Then divide each court into two halves with a line down the centre.
- Position players at the side of a court and demonstrate.
- Organise players into twos in each court area.

ACTIVITY

- Do activities in order:
 1. In twos, Player 1 throws the ball randomly to either side of the centre line using an underarm throw. Player 2 stands in a ready position with a racket ready to receive the ball. As the ball is sent Player 2 calls out where it will land - forehand or backhand. Player 2 moves to hit the ball and then recovers back to centre of the court. After five hits players change roles.
 2. In twos Player 1 hits the ball to Player 2 using a drop feed.
 3. In twos both players rally calling out forehand or backhand and recover after each shot.

EASIER

- Player 2 calls but does not move to catch or hit.

HARDER

- Do the same for short and long areas.
- Increase the size of the court.
- When hitting, Player 2 taps the ball in the air, lets it bounce and then hits.

QUALITY POINTS

- *Players should call out before the ball crosses the net if possible.*
- *Get the racket back before the ball has bounced.*
- *Turn sideways and contact the ball in front as it's falling.*
- *Stay facing the net as they recover.*
- *Small balanced adjusting steps.*

COMPETITION

In fours. Two players rally and call out forehand or backhand on their side of the net. Six shots in a row correctly called out wins a cone. The other two players are judges. Judges and players change after every rally.

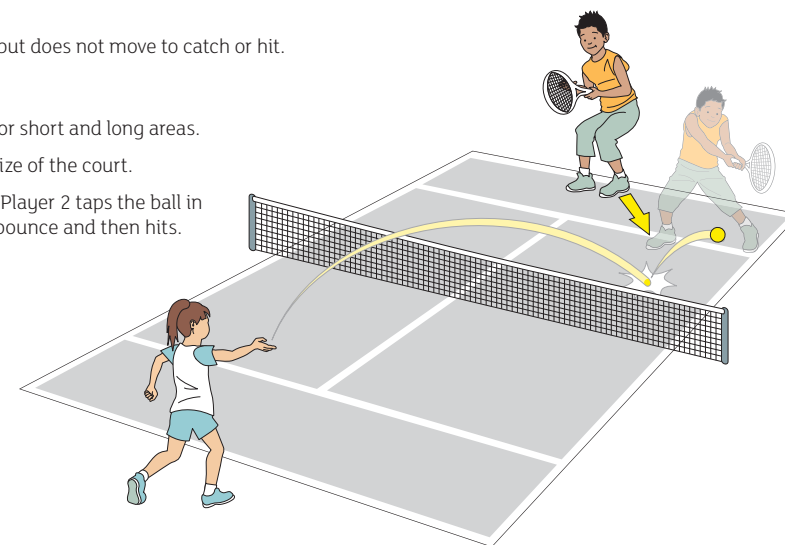

MAIN THEME

Seeing Spaces

L5

ORGANISATION

- Equipment: racket, balls, throw-down lines. Define the court area and use two lines to mark each side of one end of the court.
- Position players and demonstrate.
- Highlight safe use of rackets and balls.
- Organise players into 2s onto courts.

ACTIVITY

- Do activities in order:
 1. In twos. Player 1, at the end with the lines, sends the ball to Player 2 then runs to stand on one of the lines. Player 2 watches Player 1's position and hits the ball to the space on the court. After five hits change roles.
 2. Player 1 hits easy shots to Player 2 and recovers in the normal way. Player 2 hits first to one marker then to the other.
 3. With no markers, players rally to each other looking for the space with each shot.

EASIER

- Player 2 taps the ball in the air before hitting the ball back.
- Player 2 catches the ball and does a drop hit to the target area.
- Play Catch Tennis.

HARDER

- Freeze: Both players freeze after they hit a shot. The other player hits to the space.
- Repeat the activities using short and deep spaces on the court.

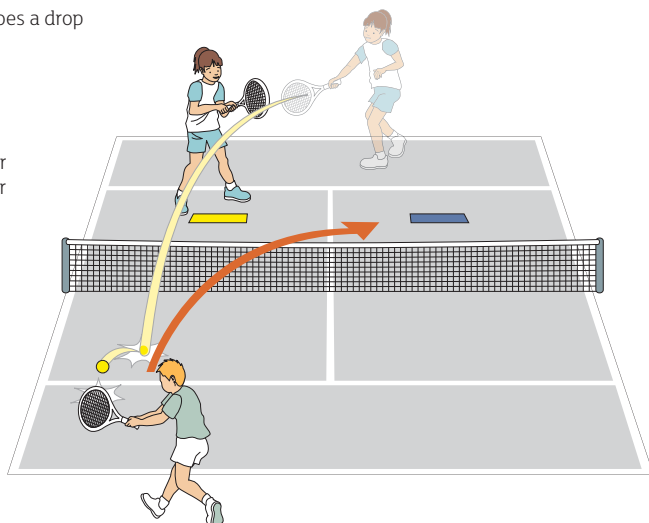

QUALITY POINTS

- *Be aware of tracking the ball and the player at the same time.*
- *Think ahead where the space is going to be.*
- *Players to move around the ball to direct it to the space.*
- *Point strings in the direction of the space.*
- *Low to high swing.*

COMPETITION

- In twos divide each end of the court into four squares using lines. Players rally with the condition that they may not hit to the same square two shots in a row.
- **Cooperative:** Count how many shots in a row with the four square conditions. Compete against other pairs.
- **Competitive:** Play points. If a player hits to the same square or misses in any way the other player wins the point.

MAIN THEME

3rd Shot Drill

L5

ORGANISATION

- Equipment: rackets, balls.
- Define the court area.
- Highlight safe use of rackets and balls.
- Position players at the side of the court and demonstrate.
- Organise players in twos, one at each end.

ACTIVITY

- In twos. Player 1 serves and then prepares for the next shot by recovering to the middle of the playing area.
- Player 2 returns the ball.
- Player 1 hits the third shot.
- Player 2 now serves.
- Progress to playing the point out.

EASIER

- Start with an overarm throw and use the racket for other shots.

HARDER

- Use only the cross court half for all three shots.

QUALITY POINTS

- *Recover after the serve and get ready watching the ball.*
- *Focus on the third shot as soon as the serve is done.*

COMPETITION

- **Cooperative:** In twos players serve and rally for three shots. Players serve alternately and have two chances for serve (see Ace Server). For every successful rally of three shots the pair wins a cone. Compete against other pairs in a set time or first to win a certain number of cones.
- **Competitive:** In twos play points. Each point starts after the third shot has crossed the net. Serving is a tie break.

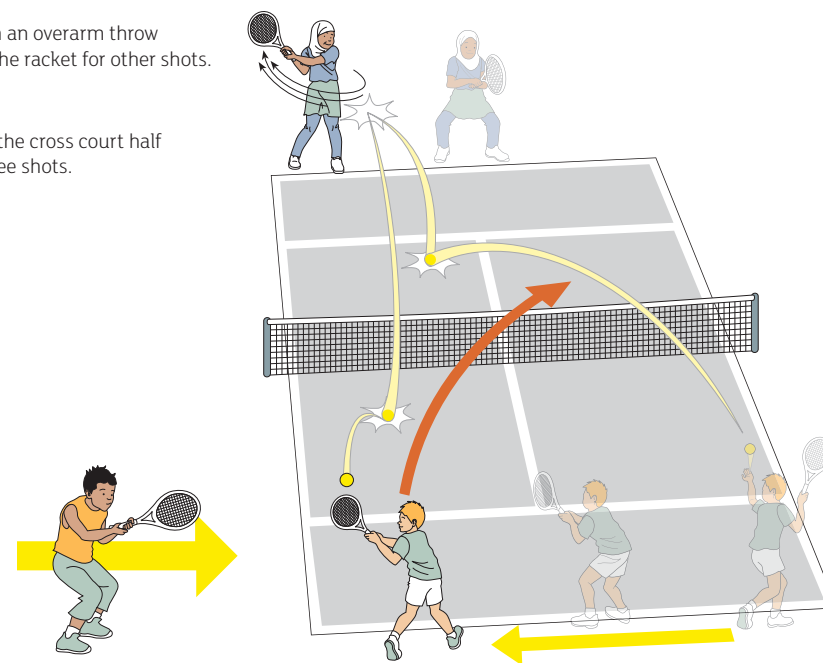

COMPETITION Tag Team Tennis

L5

ORGANISATION

- Put players in twos. It is also possible to have more than two in a team with more rotations of players.
- Match up opposing teams for matches.
- Players in teams play tie breaks against members of opposing teams.

ACTIVITY

Explain the format and scoring to the players.

- The match starts between two players (1 from each team) with the other's scoring.

- After every four points both players are 'tagged' (replaced) by their team mate and play continues.
- The scoring is continuous.
- After each tie break, rotate the order of players.
- Players score extra points for a clean winner (i.e. hit to space).

AT THE END

- Declare the winning teams.

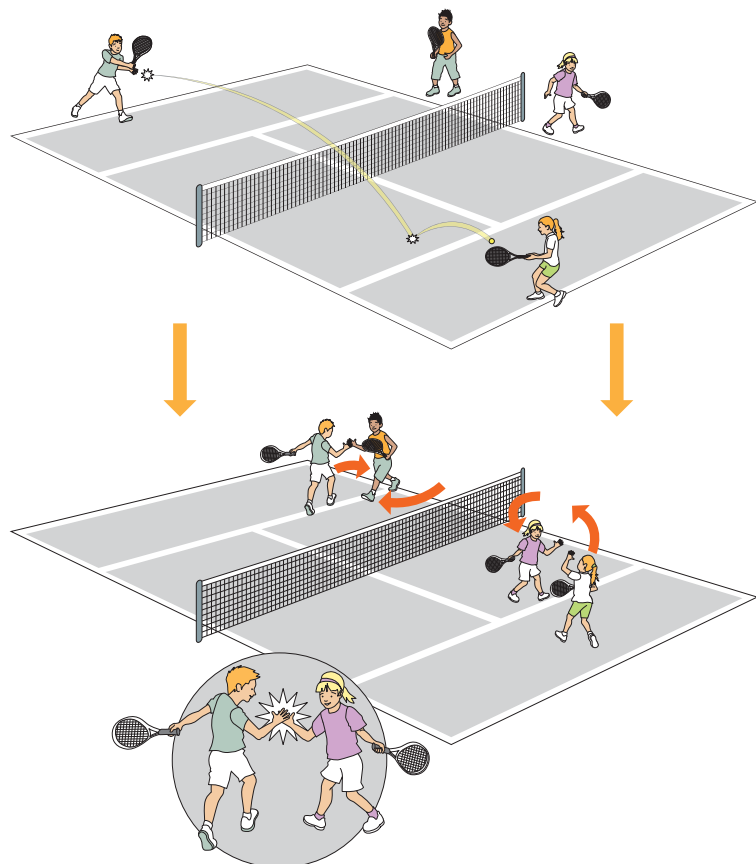

WARM-UP ACTIVITY Switch

L6

- In teams each with two rows of cones forming a track players take balls one at a time from one row and place it on another moving along the track.
- Pick up and put down with both hands or one hand and swap, etc.
- Move in different directions, rotate and balance whilst staying low.

QUALITY POINTS

- Face forwards.
- Take small steps to adjust position near each cone.
- Bend the knees and the waist to get low.
- Do this facing the net at all times.

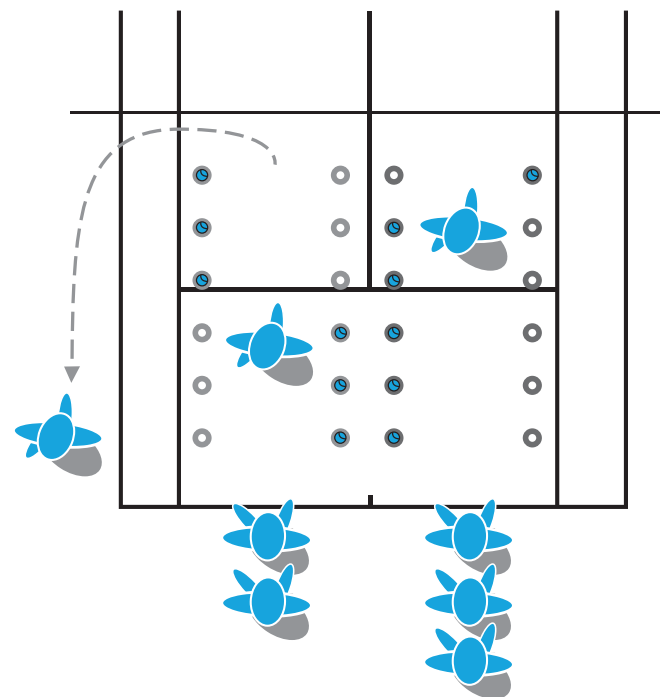

WARM-UP ACTIVITY

Throw and Go

L6

- Players line up behind a marker and use a variety of throws to pass the ball to the player in front.
- The thrower then runs to the end of the receiver's line.
- Using both hands throw forehand side, backhand side, overhead throw.
- Stop and balance before throwing, keep head and shoulders still, follow through with arms in front.

QUALITY POINTS

- *Keep your head up to watch your partner as well as the ball.*
- *Have a balanced base and light footwork.*

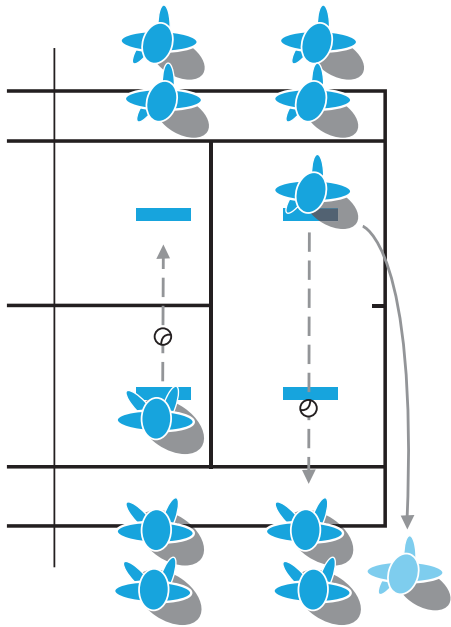

WARM-UP ACTIVITY

Step Back Rallies

L6

- Players start close to the net hitting forehands and backhands.
- With each successful hit they take a step backwards until they reach the baseline.
- Point strings in the direction the ball is intended to go.
- Turn sideways for forehands and backhands.

QUALITY POINTS

- *Get the racket back early by turning the body.*
- *Increase the length of the stroke for longer shots.*
- *Contact the ball out in front.*
- *Recover and get ready between shots.*

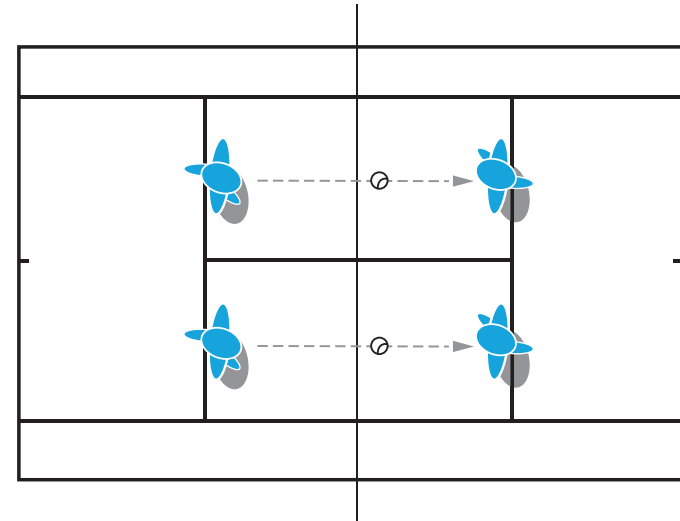

COMPETITION

Team Round Robin

L6

ACTIVITY

- This version describes the format for 16 players in four teams.
- You can adapt number of teams or number of players in a team.
- Have group scorecards ready for groups of four.
- Organise players into four teams and number the players in each team one, two, three, four in order of standard.
- All the number one players go into Group 1, the number two players go to Group 2 and so on. Therefore each group has a player from each team.

ORGANISATION

- Explain the Round Robin Format to the players
 - they play singles matches in their own group.
- Format can be altered according to time
 - can be tie breaks or three minute matches, etc.
- Each group records match scores as the matches finish.

AT THE END

- As the groups finish add up the points for each player and record the scores.
- The winning team is the team that wins the most matches or points!
- See Schools Competition Guide for templates and formats to assist in running Round Robin Competitions.

Example team score card:

	Reds	Blues	Greens	Yellow
1	10	12	9	11
2	12	8	13	9
3	9	11	10	12
4	12	8	9	13
Total	43	39	41	45

COMPETITION

Team Round Robin

L6

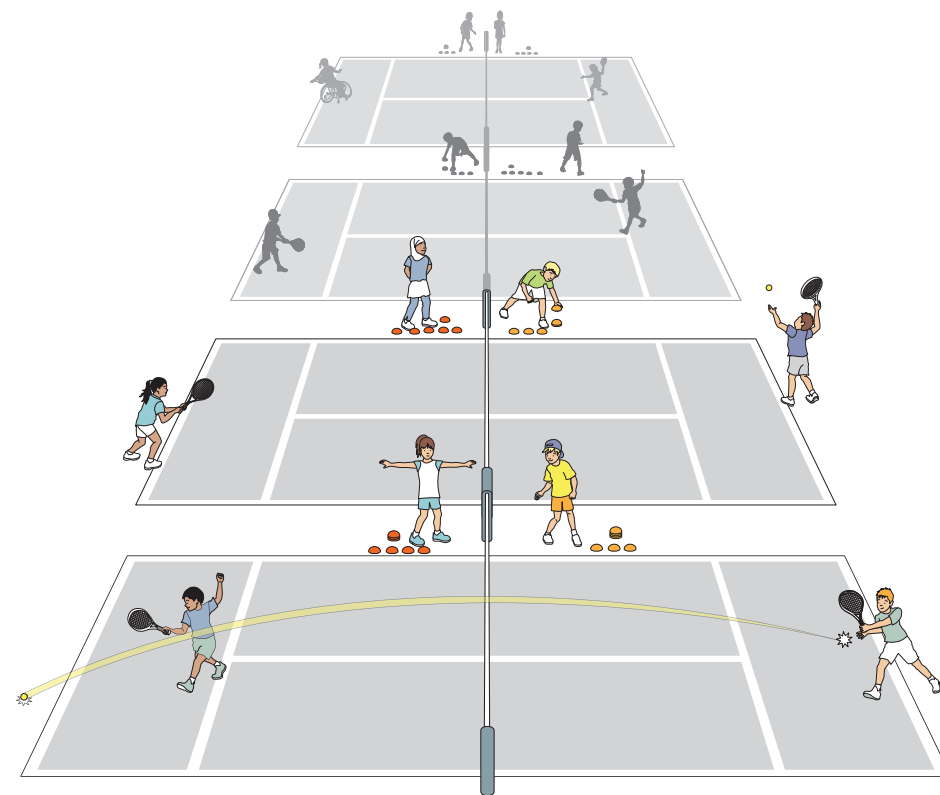

 **Mix & Match**
ACTIVITY CARDS



ABCS Cone Ladders

QUALITY POINTS

- Coordinate arms and legs, moving at the same pace.
- Keep the body upright.
- Adjust stride length for different distances.

One step between cones



Two steps between cones

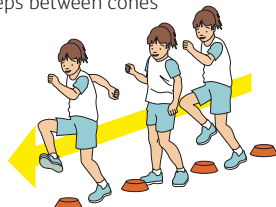

Side-steps



Cross-over steps

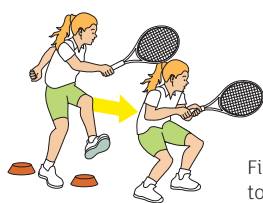

Finish with split step to ready position

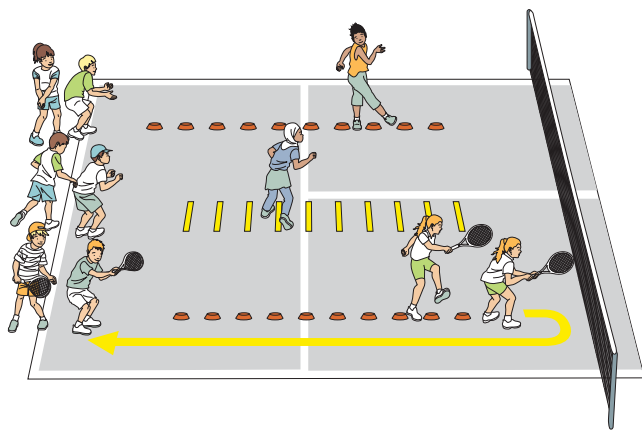

LEARNING OBJECTIVES

- Move forwards and sideways.
- Develop rhythm through repeating footwork patterns.

ORGANISATION

- Equipment: cones or throw-down lines.
- Set up a ladder for each group of 3/4 players. A ladder has 10 cones or lines in a row 30cm apart.
- Position players at the start of a ladder and demonstrate.
- Organise players into groups to start at the beginning of each ladder.

ACTIVITY

Player 1 moves through the ladder by stepping over the cones/lines in various footwork patterns, then does a split step at the end of the ladder, and then quickly turns and runs back down the side. Player 2 starts when Player 1 does the split step. Other players follow. Do this in different ways:

- With 1 foot in each space.
- With 2 feet in each space, one at a time.
- With side-steps.
- With cross over steps.
- Holding a racket.

EASIER

- Start all patterns slowly to get the footwork pattern correct and gradually increase the speed.
- Walk through the ladder.

HARDER

- Place the cones nearer together.
- Place the cones different distances apart encouraging different stride lengths.
- Change the footwork pattern halfway through the ladder.
- Make a 20 cone ladder to encourage concentration.

DISCOVER

- Where are you looking when you run through the ladder?
- What part of your feet are you running on?
- Can you think of other ways of moving through the ladder?

ABCS Switch

QUALITY POINTS

- Face forwards.
- Take small steps to adjust position near each cone.
- Bend the knees and the waist to get low.
- Do this facing the net at all times.

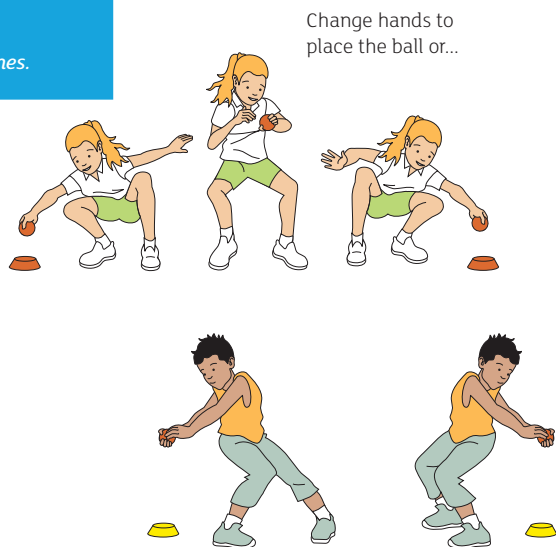

Change hands to place the ball or...

...twist to place the ball using two hands

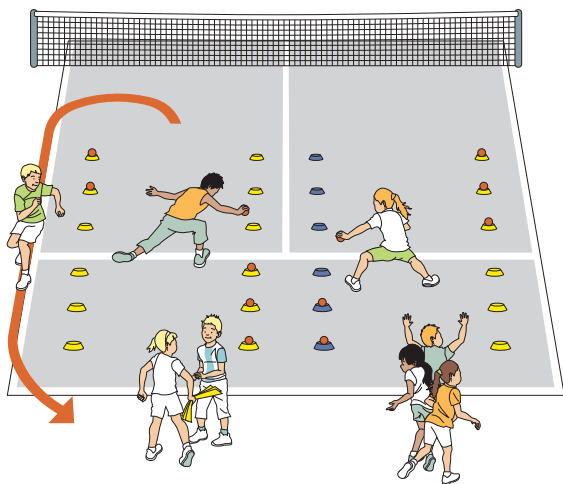

LEARNING OBJECTIVES

- Coordinate using both hands.
- Move in different directions.
- Rotate and balance whilst moving low.

ORGANISATION

- Equipment: balls, cones.
- Set up 1 track per group of 3/4 players. A track is 2 parallel lines of cones 2m apart, 6 cones in each line. One row of cones has a ball on each cone.
- Position players at the side of a track and demonstrate.
- Organise players into groups for each track.

ACTIVITY

Player 1 moves between the cones – picks up one ball at a time and puts the ball down on the cone on the opposite line. After the last cone Player 2 starts and Player 1 runs back to the beginning down the outside of the cones. Do it in 2 ways:

- Pick up with the hand nearest the cone, swap over and put down with the other hand.
- Pick up and put down with 2 hands together.

EASIER

- No balls just turning each cone over.
- No balls, just move through from side to side touching each cone.

HARDER

- Move the cones further apart to encourage more movement.
- Mark a recovery position in the centre of the start. Players recover to the mark after each ball is placed.

DISCOVER

- What kind of steps are best for moving from cone to cone?
- What are the different ways you can pick up and put down?
- Why do you face the same way all the time?

ABCS

High, Middle & Low

QUALITY POINTS

- Get ready with feet apart and hands ready.
- Work out the movement of the other player and send the ball ahead.
- Catch the ball in front of your body.

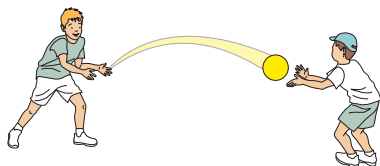

With a big ball use 2 hands and no bounces

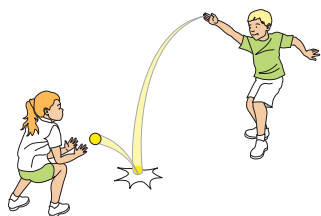

With a tennis ball let the ball bounce

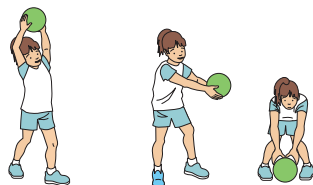
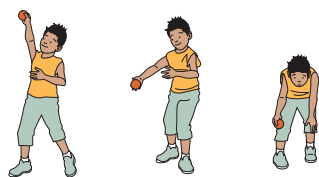

Throw in sequence - high, middle, low

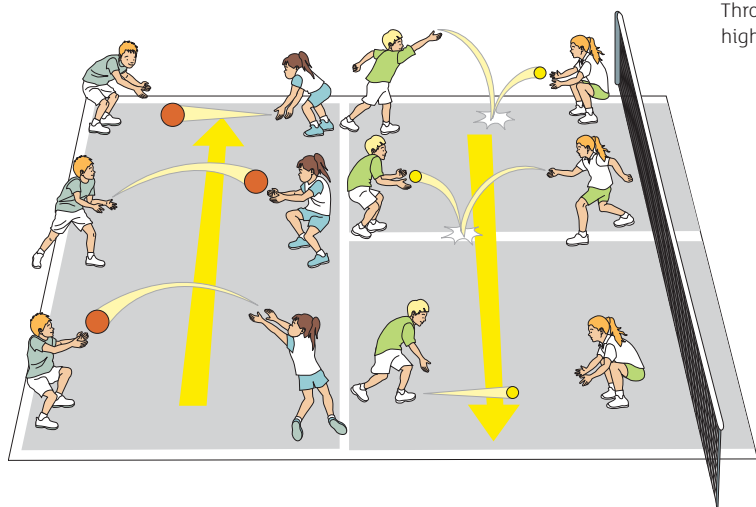

LEARNING OBJECTIVES

- Track the height of an approaching ball.
- Change body height to receive a ball.
- Balance whilst turning.

ORGANISATION

- Equipment: balls, big balls.
- Use the width of a Red court or equivalent and position players at the side to demonstrate.
- Organise players into 2s on a sideline.

ACTIVITY

Players move sideways facing each other 1m apart and throw a ball to each other. First they throw the ball above the head (High), then at waist height (Middle), and then roll it along the floor (Low). Players continue throwing in this sequence. On a Teacher command players change direction. Do the activity in 2 ways:

- Throw and catch with no bounces with a big ball and 2 hands on the ball.
- Throw and catch with bounces with a Mini Tennis ball with 1 hand for throwing and 2 hands for catching.

EASIER

- Stand still and throw.
- Start with just high and low, and add middle.

HARDER

- With a Mini Tennis ball with no bounces.
- Add moving forwards and backwards.
- Throw with 2 hands on the ball and rotate the body whilst moving.
- 1 handed catching and throwing.
- Non-dominant hand.

DISCOVER

- What direction do you send the ball when you are moving?
- How should your hands get ready for catching the different throws?
- How big are your steps when you move sideways?

MAIN THEME

Catch Tennis

QUALITY POINTS

- Throw underarm with a smooth arm swing at the side of the body.
- Recover after the throw and get ready for the next catch.
- Get ready for the catch with hands in front, palms forward and fingers down.
- Get behind the bounce of the ball.
- Control the catch using soft hands.

Throw the ball up and catch it in a cone...

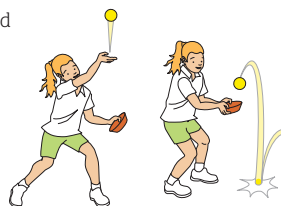

Catch and throw with a partner

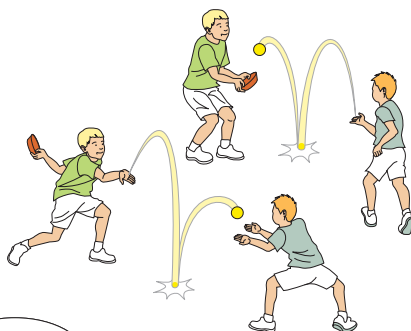
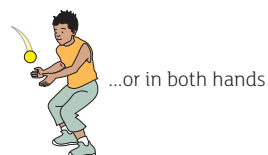

COMPETITION

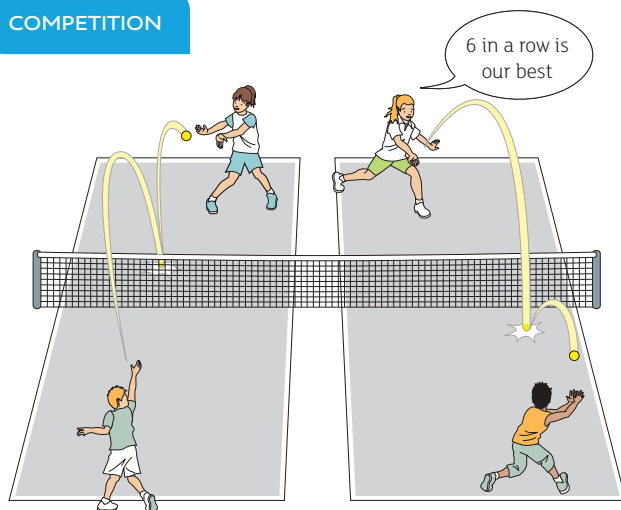

LEARNING OBJECTIVES

- Throw underarm with control of speed and direction.
- Read the flight and direction of the ball – bouncing, rising and falling.
- Catch the ball near the ideal contact point as it falls.

ORGANISATION

- Equipment: balls, cones.
- Position players at the side of the area and demonstrate.
- Define playing area.
- Organise players into spaces.

ACTIVITY

Do activities in order:

1. Solo: Throw the ball up, let it bounce, rise, start to fall and then catch it with an upturned cone using 1 or 2 hands.
2. Solo: Throw the ball up let it bounce, rise, fall and catch it with 2 hands.
3. In 2s: 4m apart. Player 1 with a ball and Player 2 in the ready position holding an upturned cone with 1 or 2 hands. Player 1 throws the ball towards Player 2 lets it bounce, catches it in the cone and then throws it back. The catch should be out in front.
4. In 2s player rally over the net throwing and catching in a defined area. Throw the ball further away from the partner – higher, lower, shorter and wider. Player throw from wherever they catch it and then recover the middle and get ready (see Home Base).
5. Add an overarm throw for the first throw in the rally to stimulate serve.

EASIER

- Catch the ball in a bag or bucket.
- Use a bigger ball.
- Roll the ball along the ground.

HARDER

- Throw and catch with 2 hands.
- In 2s make the court bigger and make each other move around more.

DISCOVER

- Where should you meet the ball to catch it?
- What was the ball doing when you caught it?
- How is the bounce different when the ball goes higher or lower?

COMPETITION

Mark out a small court area with a net or similar. In 2s players rally with a ball in a defined court area. Each rally starts with an overarm throw and if the ball goes out of the area the rally stops:

1. Count how many catches in a row. Remember best score. Compete against other pairs.
2. Race to do 10 catches in a row.

MAIN THEME

Home Base

QUALITY POINTS

- Get ready, balanced, feet apart, knees bent and ready to move.
- Recover quickly.
- Look at the ball during recovery.

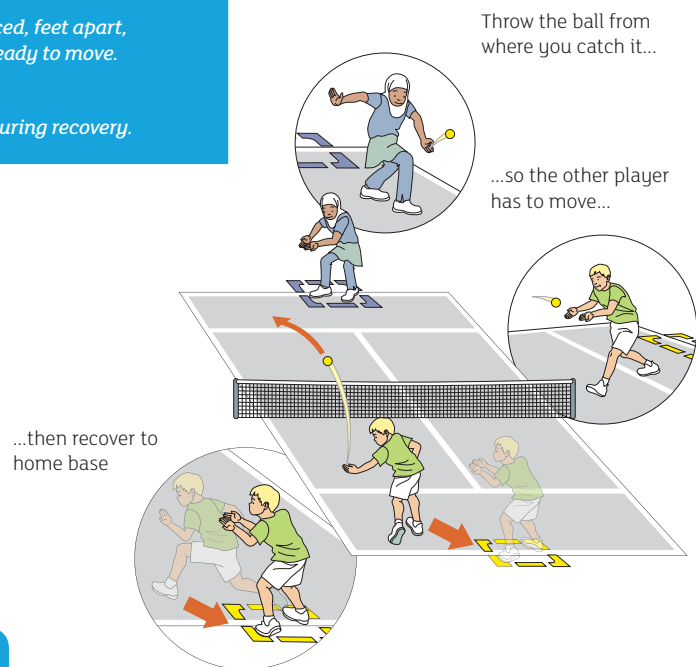

COMPETITION

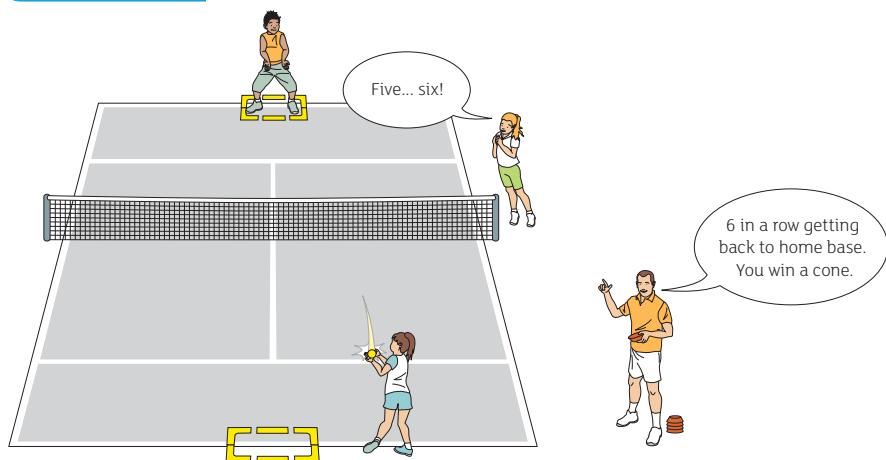

LEARNING OBJECTIVES

- Recover to the centre of the playing area after moving away from it.
- Use appropriate footwork for recovery and getting ready.
- Face the front and watch the ball during recovery.

ORGANISATION

Players should have experienced Catch Tennis before playing Home Base.

- Equipment: balls, throw-down lines.
- Define a court area suitable for the throwing ability of players and mark a Home Base at each end using lines.
- Position players at the side of a court and demonstrate.
- Organise players into 2s in each court area.

ACTIVITY

In 2s play Catch Tennis. Players throw the ball to each other so that they have to move away from Home Base to catch it. Players throw the ball from the place they catch it and then recover to the home base.

EASIER

- Stop after each catch to give the other player a chance to return to Home Base.
- Use a bigger or slower ball.

HARDER

- Increase the size of the court.
- Catch and throw with 2 hands on both sides.
- One player hits the ball.
- Both players hit the ball.

DISCOVER

- How quickly can you tell which direction the ball is moving?
- How do you move to stop the ball?
- Where is the best contact point?

COMPETITION

In 2s rally through cones:

1. Count how many hits in one rally and remember best score. Compete against other pairs.
2. For every rally of 6 shots in a row win a cone. Collect cones for 2 minutes.
3. Race to do a rally of 10 in a row.

MAIN THEME

Rally 1-2-3

QUALITY POINTS

- Get the racket back before the ball has bounced.
- Hit the ball 1-2m above the net in arc shape.
- Show a more consistent shape of stroke.
- Contact the ball out in front.

Recover to behind the baseline

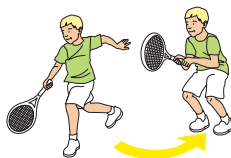

Count the number of consecutive hits

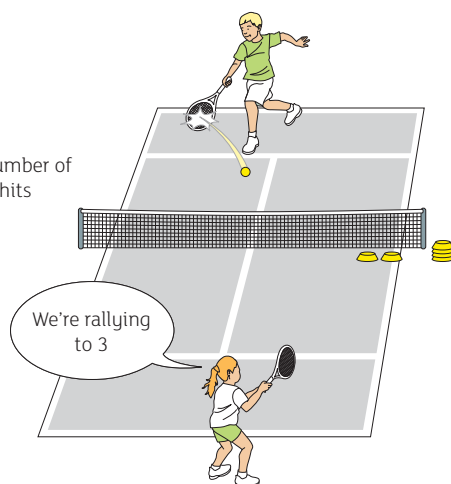

COMPETITION

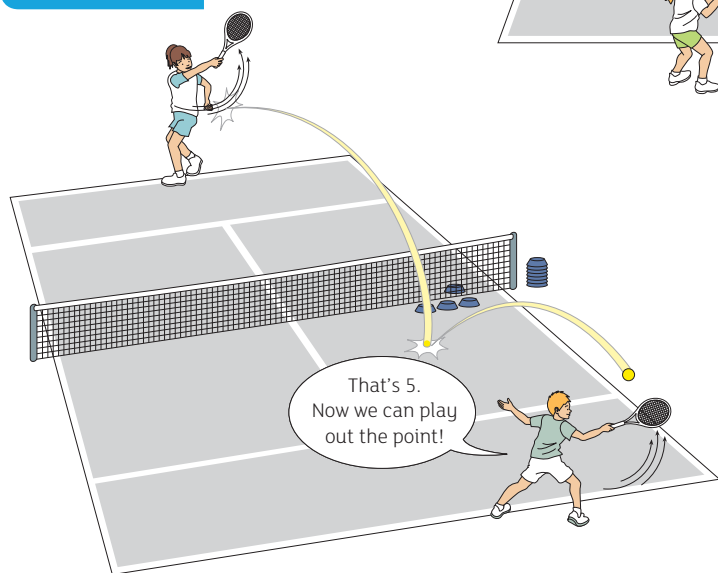

LEARNING OBJECTIVES

- Think about consistency of keeping the ball over and in.
- Show a consistent stance, contact and action.

ORGANISATION

- Equipment: rackets, balls, throw-down lines, cone.
- Define the court area and set the baseline appropriate for the ability of the players. Mark the centre of the baseline using a line.
- Position players at the side of the court and demonstrate.
- Highlight the need to stop if another player gets near.
- Organise players into 2s onto courts.

ACTIVITY

In 2s, players rally, starting with an overarm throw or serve and between shots recover to the centre of their baseline. Players count the number of consecutive hits. The first rally has an easy target of 1. When this is achieved the players put a cone at the net. The next rally target is 2: when this is achieved they put another cone at the net. The next rally count is 3 and so on. So when there are 4 cones at the net, they are aiming to get 5.

EASIER

- One hitter and 1 catcher.
- Catch tennis rally.
- Floor tennis under the net.

HARDER

- Rally cross court.
- Add conditions to the rallies, e.g. 1 player hits backhands only.
- Players hit alternate forehands and backhands.
- Players set their own target to win a cone.

DISCOVER

- How does the action relate to where the shot goes?
- Why is it important to recover?
- What do you think about when you want to rally consistently?

COMPETITION

Cooperative: In 2s rally and count, and collect cones in a set time. Compete against other pairs.

Competitive: In 2s players play points. They serve alternately using an overarm serve if possible. The first point must have at least 1 shot before they can compete. The next point must have at least 2 shots before they can compete. The next point must start with 3 shots before they compete, and so on. The first player to win 5 points wins the match. If the initial target number is not reached the point is player again.

MAIN THEME

Step Back Rallies

QUALITY POINTS

- Get the racket back early by turning the body.
- Increase the length of the stroke for longer shots.
- Contact the ball out in front.
- Recover and get ready between shots.

Measure out 5 racket lengths from the net

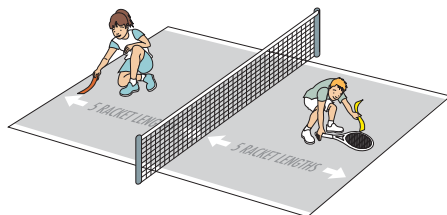

Rally to 6 in a row then move the line back one racket length

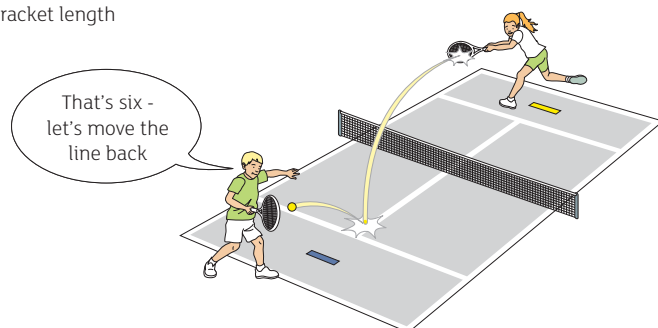

COMPETITION

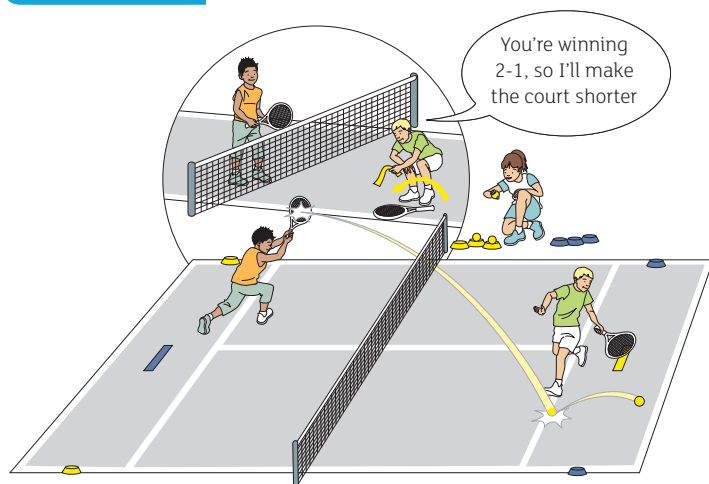

LEARNING OBJECTIVES

- Control the hitting action over different distances.
- Develop a cooperative rally.

ORGANISATION

- Equipment: rackets, ball, throw-down lines.
- Define the court area.
- Position players at the side of the court and demonstrate.
- Highlight the need to stop a shot if another player is near.
- Organise players into 2s on courts.

ACTIVITY

Each player measures 5 racket lengths from the net at their end of the court and puts down a line for the centre of their baseline. Players rally over the net and count the number of shots in a row within smaller court space, always recovering to their baseline. Each time they rally 6 in a row they both move the line back 1 racket length.

EASIER

- One player hits and the other throws and catches.
- Catch tennis rally.
- Floor tennis rally under the net.

HARDER

- Start each rally with an overarm serve.
- Players hit alternate forehands and backhands.
- Players are not allowed to step in front of the line to hit the ball.

DISCOVER

- How does the stroke length change over different distances?
- What different ways can you hit the ball to make it go further?
- Why is it important to recover to the centre of the baseline?

COMPETITION

Cooperative: Race other pairs to see who can get further back in a set time.

Competitive: Players create a baseline 5 rackets lengths from the net on each side and play points. After every 3 points the player that is losing can say 'longer' or 'shorter' and the court must be made 1 racket longer or 1 racket shorter for the next 3 points.

MAIN THEME

Underarm Server

QUALITY POINTS

- Start balanced and sideways behind the line.
- Hold the ball out and near the racket face.
- Put the ball gently in the air a little higher than the hand and racket.
- Tap the ball gently at first.

Start 5 racket lengths back from the net then move further back

Catch the ball with hand and racket

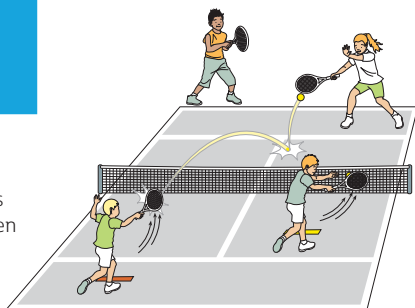

Underarm serve

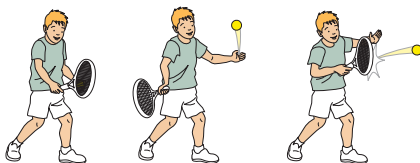

COMPETITION

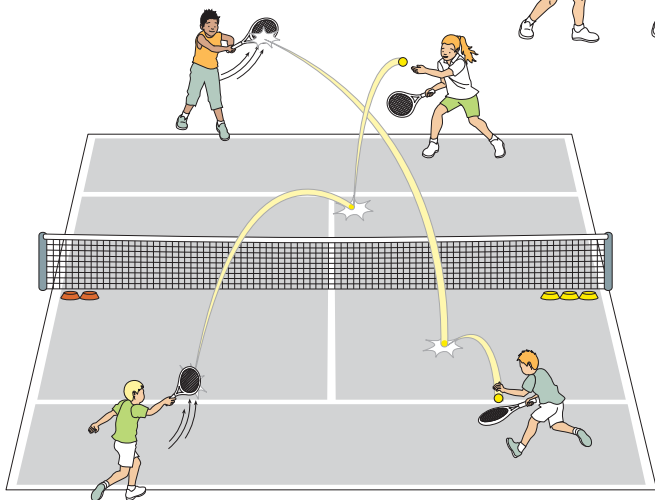

LEARNING OBJECTIVES

- Coordinate both arms in an underarm serve action.
- Contact and control the ball in an underarm serve action.

ORGANISATION

- Equipment: rackets, balls throw-down lines.
- Define the service area and the diagonal service boxes.
- Position players at the side of the court and demonstrate.
- Highlight the need to check other players are not near before serving.
- Organise players into 2s, 1 at each end of the court.

ACTIVITY

Do activities:

1. In 2s diagonally opposite each other and each puts down a line 5 racket lengths from the net. Player 1 stands sideways and behind the line. The action starts with a small split of the arms, gently placing the ball upwards and tapping it with the racket so that the ball goes over the net and into the service area. Player 2 stands in the ready position and watches the first bounce of the ball and calls in or out, then catches it with hand and racket, and serves it back.
2. Change sides and serve to the other diagonal.
3. Players gradually move their line further back and increase the size of the split of the arms to hit it further.

EASIER

- Start nearer to the net.
- Start next to the net. Hold the ball on the racket strings and push it over the net.
- Hit with the hand rather than the racket.
- Throw underarm.

HARDER

- Make the target area smaller.
- Player 2 hits the ball back if it lands in the service area.

DISCOVER

- How do you hold the ball before you place it?
- Where do you need to place the ball in order to control the hit?
- What happens if you throw the ball too high, too low, too far forwards or backwards?

COMPETITION

1. 'I serve you catch' – in 2s players serve to each other so that the partner catches it with the racket and hand. Players win a cone for every successful catch. They compete against other pairs in a set time.
2. In 2s players serve alternatively from a start line. Every time a player serves successfully they move the line back 1 racket length. Each player tries to get further back than their partner in a set time.

MAIN THEME

Target Tennis

QUALITY POINTS

- *Balanced alert ready position.*
- *Angle the racket face to the target.*
- *Increase the path of the push to get the ball to go further.*

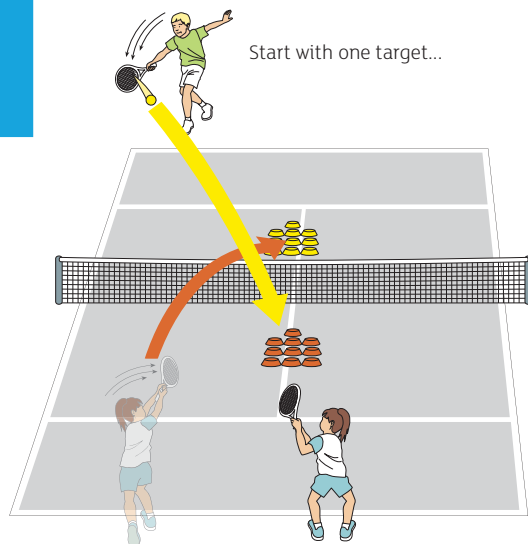

...then progress to a target for each player

COMPETITION

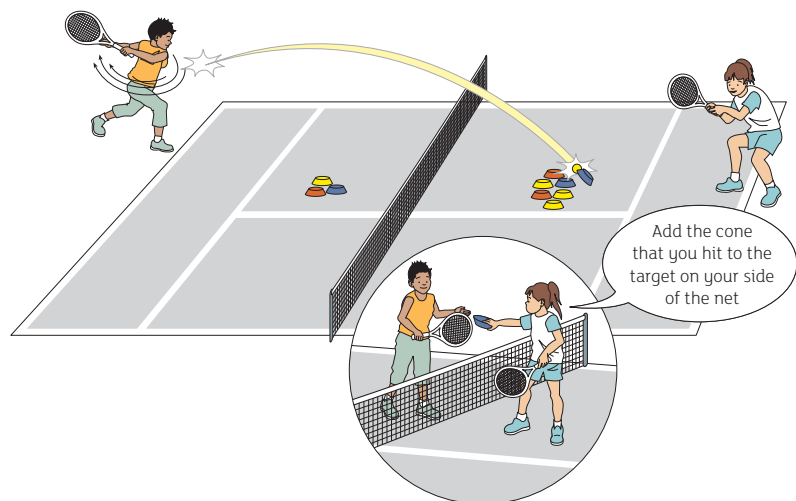

LEARNING OBJECTIVES

- Get into the correct position to hit the ball in the required direction.
- Control the contact point and racket action to send the ball to the target.
- Get ready between each shot.

ORGANISATION

- Equipment: rackets, balls, cones.
- Define the court area and at one end create a target using a cluster of 5 cones.
- Position players at the side of the court and demonstrate.
- Highlight safe use of the rackets and cones.
- Organise players into 2s onto courts.

ACTIVITY

Do activities in order:

1. Player 1 stands behind the target. Both players rally. Player 2 aims at the target. Both players always return to a ready position between shots and use both forehand and backhand shots. Change roles after 10 shots.
2. Each player has a target and both players rally aiming at the targets.

EASIER

- *One player throws whilst the other hits to the target.*
- *Players throw to the target.*

HARDER

- *Player 1 hits to different places and Player 2 still aims at the target.*
- *Create 2 separate targets and Player 2 hits to alternate targets.*
- *Increase the distance to the targets.*

DISCOVER

- How early can you tell if the ball is going to the forehand or backhand side?
- How can you see the target and the ball at the same time?
- How do you make the ball go to the target?

COMPETITION

In 2s each with a cluster of cones as a target in front of them. Players rally aiming to hit the target. Every time a cone is hit it is removed from that target and added to the other player's target. After a set time the player with the most cones in front of them is the winner.

MAIN THEME

Rally & Recover

QUALITY POINTS

- *Balanced, alert ready position.*
- *Complete the shot before recovering.*
- *Keep watching the ball during recovery.*

Move after playing your shot

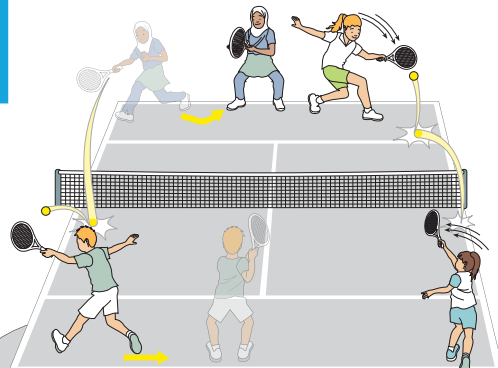

Take two steps back towards the middle of the court

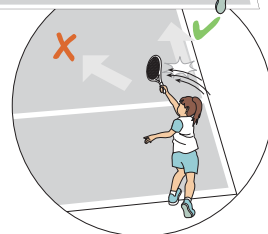
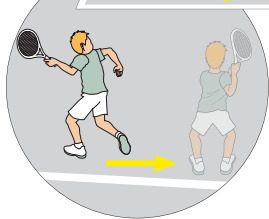

Keep the ball to the outside of the court

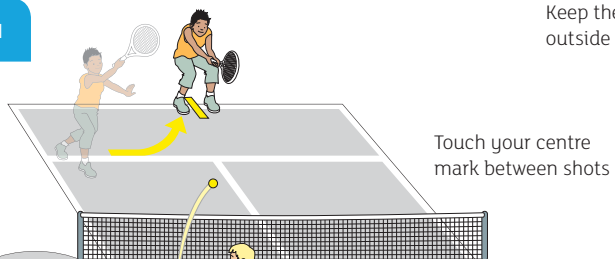

Touch your centre mark between shots

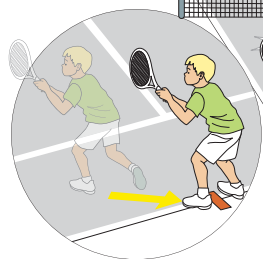

COMPETITION

LEARNING OBJECTIVES

- Recover to the centre of full court.
- Show appropriate footwork during recovery.

ORGANISATION

- Equipment: rackets, balls.
- Define the court and the half court tracks.
- Position the players at side of the court and demonstrate.
- Highlight the need to stop if another player is near when hitting, especially in the middle of the court.
- Organise players in 2s into half court tracks.

ACTIVITY

Do activities in order:

1. In 2s players rally in a half court track. After each shot they recover towards the middle of the full court with at least 2 steps in the recovery. Players focus on hitting the ball and then recovering. Shots should be directed to the appropriate half court. Always stop if the ball goes near the middleand near the player on the other half track.
2. Rally in the cross court half track.

EASIER

- *Only 1 player does the 2 step recovery then change roles after 10 hits.*
- *Player 1 throws and Player 2 hits and recovers.*
- *Play in a shorter court.*

HARDER

- *Use specific movement patterns for recovery.*
- *In cross court rallies use the outside shot i.e. forehand on the backhand side and backhand on the forehand side.*

DISCOVER

- At what point after hitting the ball does your recovery start?
- What do the feet and legs do to start a quick recovery?
- What role do other body parts play in a good recovery?

COMPETITION

Cooperative: In 4s. 2 players rally, both doing a 2 step recovery to the middle. 2 players are judges. A successful rally of 6 in a row wins a cone. After 1 minute players and judges change roles. Compete against the other pairs.

Competitive: In 4s. 2 players rally. If either player does not do a 2 step recovery the other player wins a cone. 2 players are judges. After a set time the player with the most cone wins.

MAIN THEME

Seeing Spaces

QUALITY POINTS

- Be aware of tracking the ball and the player at the same time.
- Think ahead where the space is going to be.
- Get in the correct position to direct the ball to the space.

Play the ball to the opposite spot from your opponent

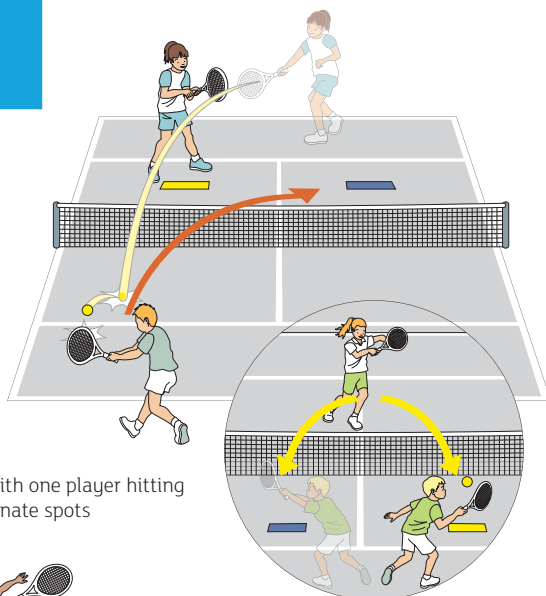

Rally with one player hitting to alternate spots

COMPETITION

You cannot hit to the same square twice in a row

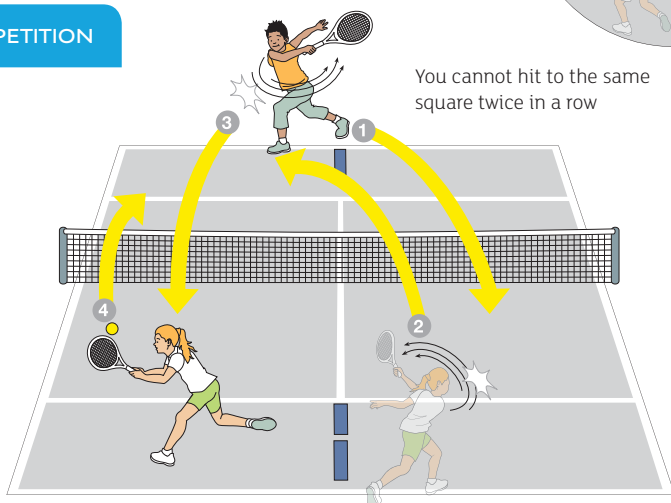

LEARNING OBJECTIVES

- Be aware of the position of the opponent.
- Work out where spaces are – sides, short and deep.
- Direct the ball to the space and move the opponent.

ORGANISATION

Players should already have an understanding of how to win a point and the reason for moving an opponent. Use the card Winning a Point.

- Equipment: racket, balls, throw-down lines.
- Define the court area and use 2 lines to mark each side of one end of the court.
- Position players and demonstrate.
- Highlight safe use of rackets and balls.
- Organise players into 2s onto courts.

ACTIVITY

Do activities in order:

1. In 2s. Player 1, at the end with the lines, sends the ball to Player 2 then runs to stand on 1 of the lines. Player 2 watches Player 1's position and hits the ball to the space on the court. After 5 hits change roles.
2. Player 1 hits easy shots to Player 2 and recovers in the normal way. Player 2 hits first to one marker then to the other.
3. With no markers, players rally to each other looking for the space with each shot.

EASIER

- Player 2 taps the ball in the air before hitting the ball back.
- Player 2 catches the ball and does a drop hit to the target area.
- Play Catch Tennis.

HARDER

- Freeze: both players freeze after they hit a shot. The other player hits to the space.
- Repeat the activities using short and deep spaces in the court.

DISCOVER

- How can you watch the opponent and the ball at the same time?
- How does your action change to hit to different places?
- How does your footwork change to hit to different places?

COMPETITION

In 2s divide each end of the court into 4 squares using lines. Players rally with the condition that they may not hit to the same square 2 shots in a row.

Cooperative: Count how many shots in a row with the 4 square conditions. Compete against other pairs.

Competitive: Play points. If a player hits to the same square or misses in any way the other player wins the point.

MAIN THEME

Ace Server

QUALITY POINTS

- For overarm serve complete beginners start square onto the net.
- Push ball and racket up together, placing ball slightly in front.
- Make contact above your head.
- Tap the ball upwards gently and stay high with your racket.

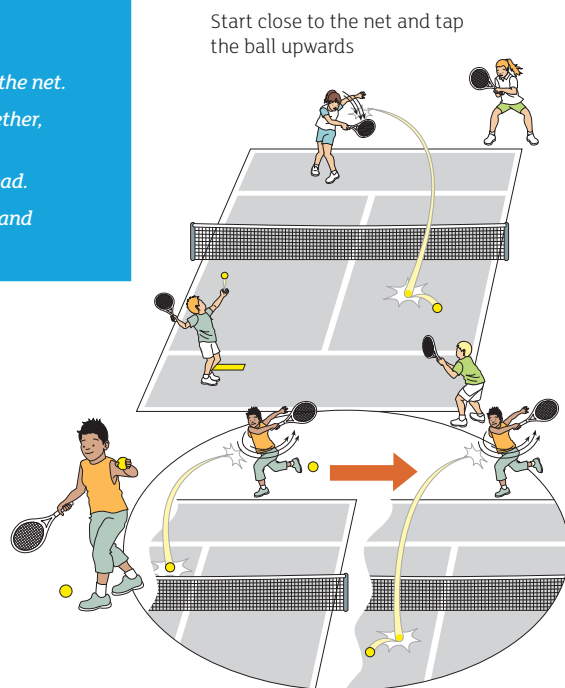

COMPETITION

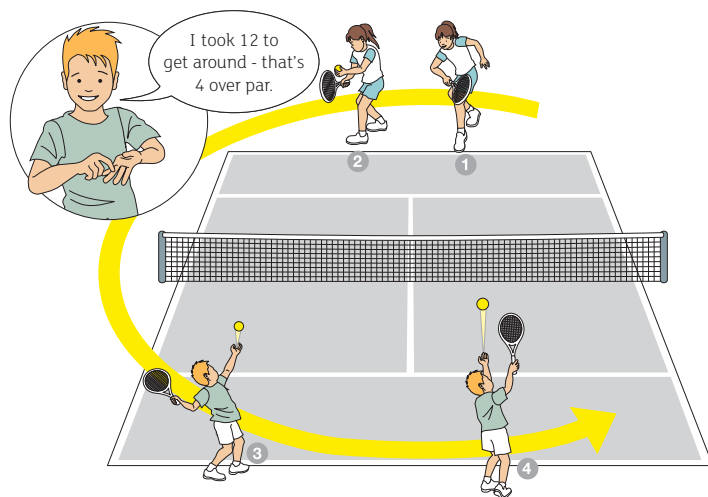

LEARNING OBJECTIVES

- Serve consistently over and in to the diagonally opposite service box.
- Develop a full service action, starting with a tap from contact point.
- Know the rules about serving.

ORGANISATION

- Players should already have an understanding of a basic overarm throwing action.
- Equipment: rackets, balls.
- Define the court area and service boxes. Start with a very small court and make the courts progressively larger.
- Position players at side of court and demonstrate.
- Highlight safe use of rackets, especially in the area behind during a serve.
- Organise players into serving places on the court.

ACTIVITY

Do activities:

1. Each player starts with 2 balls, sets up behind the service line (or further back if they can) ready to serve. Each player serves 2 serves from the right and 2 from the left changing places with the partner.
2. Each player starts with 2 balls. Each player serves (first serve) and only serves the second ball (second serve) if the first serve is missed. If both are missed this is a double fault. Keep changing sides.

EASIER

- Start nearer the net.
- Help the player placing the ball.
- Start with a slightly bent arm very close to contact point.

HARDER

- Move step by step from frontal stance to 45° angle with the net to sideways, to backwards in a loaded position.
- Move step by step from a tap up to a hit feeling, always stay high with the racket after contact point.
- Always keep tapping upwards.

DISCOVER

- Does it count as a serve if you try to hit the ball but miss?
- How do you stand differently to serve from right and left?
- What happens if you step inside the court when you serve?

COMPETITION

Par for the Court: Every player serves from 4 serving spots on the court going round the court from spot 1 to spot 4. At each spot they stay and serve until a serve goes in. Each player counts how many serves it takes to get around the court. They compare their scores to par which is 8. 8 = Par server, 7 = 1 under par, 6 = 2 under par, 5 = 3 under par, 4 = 4 under par and Ace server, 9 = 1 over par, 10 = 2 over par, etc.

The aim is to improve the score against par next time. Can also be played over 8 spots and 2 courts (par 16).

MAIN THEME

3rd Shot Drill

QUALITY POINTS

- Recover after the serve and get ready watching the ball.
- Focus on the 3rd shot as soon as the serve is done.
- Show good actions for all the shots.

Recover to ready position after serve

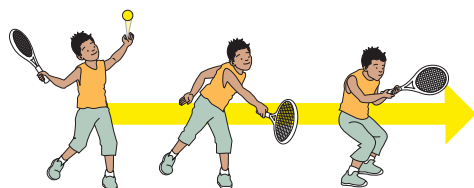

Play the third shot to the opposite side from the serve

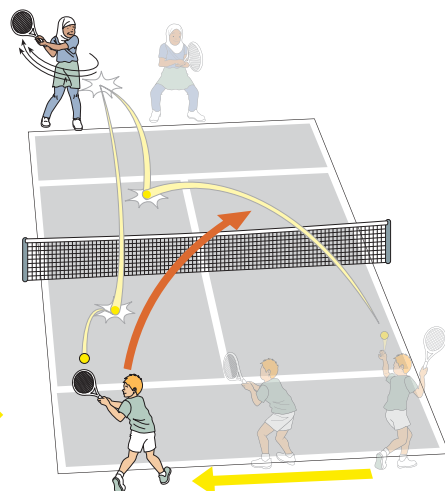

COMPETITION

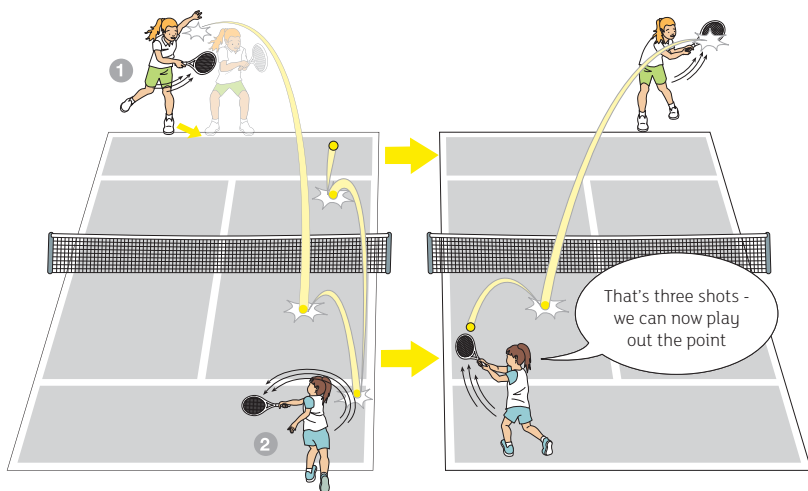

LEARNING OBJECTIVES

- Recover from the serve and prepare for the next shot.
- Get the ball over and in.
- Develop the actions for serve, return of serve and groundstrokes.

ORGANISATION

Players should have already learnt Serve, Return of Serve and Seeing Spaces. Use Overarm Server, Return the Serve and Seeing Spaces.

- Equipment: rackets, balls.
- Define the court area.
- Highlight safe use of rackets and balls.
- Position players at the side of the court and demonstrate.
- Organise players in 2s, one at each end.

ACTIVITIES:

1. In 2s. Player 1 serves and then prepares for the next shot. At the other end Player 2 watches Player 1 to see if they prepare for the next shot by getting to the middle of the playing area in the ready position. Player 2 then collects the ball and does the same.
2. As above adding that Player 2 returns the ball and Player 1 hits the 3rd shot into the space on the other side. Both players recover and show they are ready for the next shot before they stop and start the next rally.

EASIER

- Start with an overarm throw and use the racket for other shots.

HARDER

- Use only the cross court half for all 3 shots.

DISCOVER

- What do you need to do after the serve to be ready for the next shot?
- Where do you want to direct the 3rd shot?

COMPETITION

Cooperative: In 2s players serve and rally for 3 shots. Players serve alternately and have 2 chances for serve (see Ace Server). For every successful rally of 3 shots the pair wins 1 cone. Compete against other pairs in a set time or first to win a certain number of cones.

Competitive: In 2s play points. Each point starts after the 3rd shot has crossed the net. Serving is a tie break.

MAIN THEME

React 'n Volley

QUALITY POINTS

- *Balanced ready position.*
- *Short block action.*
- *Racket face angled to target*

Throw 3 balls to forehand side, then 3 balls to backhand. Then throw a mix of forehands and backhands.

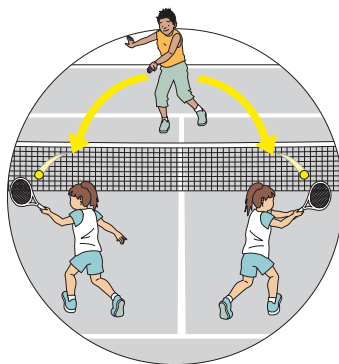

Recover to ready position after each volley

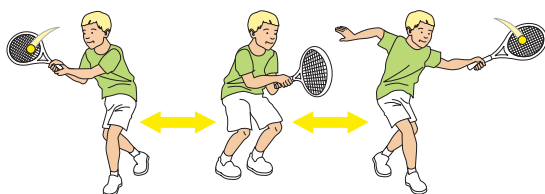

COMPETITION

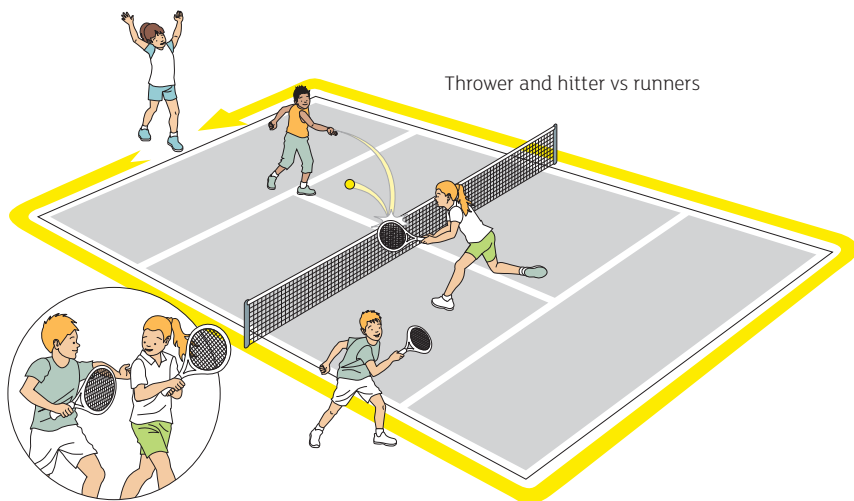

Thrower and hitter vs runners

LEARNING OBJECTIVES

- Understand when to volley.
- Contact the ball in front.
- Get the ball over and in.

ORGANISATION

Players should have experience of Catch Tennis without bounces, reaction exercises such as in ABCs card Mirror Me and split step exercises such as in various ABCs cards.

- Equipment: rackets, ball.
- Define the court area and the volley position (from the net racket, stretch and step back).
- Position players and demonstrate.
- Highlight safe use of rackets and balls.
- Organise players into 2s, one at each end.

ACTIVITY

Do activities:

1. In 2s Player 1 throws 3 balls to Player 2 on the forehand side. Player 2 starts with the racket out at the side ready to gently tap the ball with a small volley action hitting the ball out in front and at the side. Player 2 throws 3 balls to the backhand side of Player 2 in the same way. Players change roles.
2. As above, but Player 1 throws a mix of forehands and backhands and Player 2 starts in the ready position for each volley.

EASIER

- *Player 2 catches the ball with the hand.*
- *Player 2 bats the ball with a hand with the palm forward.*

HARDER

- *Player 2 does a split step just before Player 1 throws the ball.*
- *Player 1 throws the ball more quickly to help Player 2 quickly.*
- *Player 1 hits the ball to Player 2.*

DISCOVER

- Why is it important to get back to the ready position?
- Where does your racket finish when you hit a good volley?
- What happens if you volley at the baseline and the ball was going out?

COMPETITION

Cooperative: In 4s in a 2v2 race. Pair 1 do 'throw, volley and catch' as many times as possible while Pair 2 run all the way around the court out at a time. Change roles. The pair with the highest number of catches wins.

Cardio Tennis

ACTIVITY CARDS
AND LESSON PLANS





CARDIO TENNIS

Get young people bouncing to the beat with Cardio Tennis!

Cardio Tennis is a tennis inspired workout played to up-tempo music. It's a fun group activity that features drills and games providing a high energy workout, it is suitable for everyone including those that haven't played tennis before through to advanced players. By using low compression balls, it allows everyone to have a great cardio workout whilst being able to achieve and improve tennis skills at the same time.

Participants are encouraged to wear heart rate monitors or pedometers, so they can see how hard they are working. The measure of success becomes the participant's heart rate, or the number of steps they have taken, rather than the number of balls they hit over the net and into the court. Cardio Tennis is a fantastic adapted version of the game, ideal for encouraging disengaged groups to take part in the sport, it has also proved to be a great way of encouraging women and girls to participate and also retaining those that already play. Cardio Tennis can take place outside on a tennis court or inside in a sports hall.

Key to diagrams

- BB** Ball Bucket
- C** Catcher
- F** Feeder
- H** Hitter
-  Ladder
- R** Receiver
- T** Teacher
-  Throw Down Spot

Design Your Club



- Give everyone pedometers so they can record the number of steps taken each session and compare sessions to beat their personal best number of steps! They could run a 'PB leader board'.
- Encourage the group to bring along their own 'playlist'.
- Split into small groups and task each group with designing their own Cardio Tennis drill or even a full session, which they can combine with their selected 'playlist'.

GUIDANCE AND ADAPTATIONS

The activities and drills within this resource have been designed to be delivered on a tennis court / playground or inside in a sports hall.

For ease of understanding, each of the activity and drill cards illustrate the activity taking place on a Mini Tennis Red court.

WARM-UP ACTIVITY

Hit and Move



- Hitters form two lines at the baseline.
- Feeders and ball bucket on each sideline.
- Feeders drop feed ball onto target area. Hitters move in and hit forehand/ backhand (whichever is their outside shot).
- Hitters move through ladder and join end of the other line.
- Players on other side of the net catch or collect.
- Variation: have two feeders and move the ball bucket away from the feeder so they need to run to collect a new ball between shots.

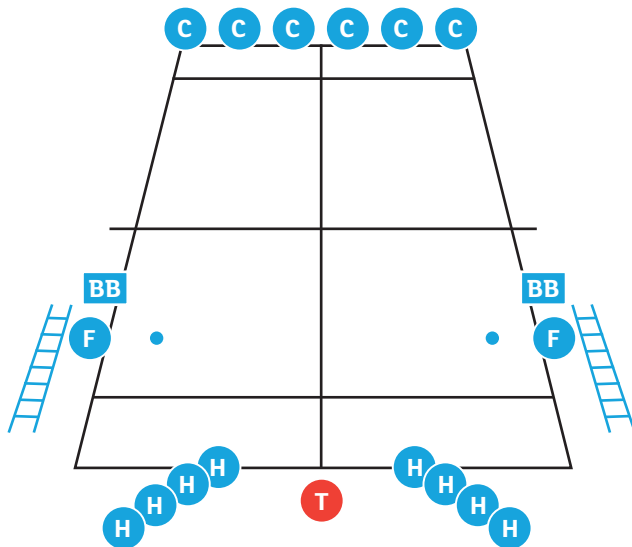

WARM-UP ACTIVITY

Harlem Shuffle



- Line up players as partners on sideline with a foam ball.
- Players 1 and 2 shuffle step to the opposite sideline as they throw and catch the ball to each other. Players 3 and 4 follow and so on. Players move through the ladder back to starting sideline.
- Be creative: catch out of the air, use two balls, bounce catch, or turn it into a competition. Can be done as volleys with more advanced players.

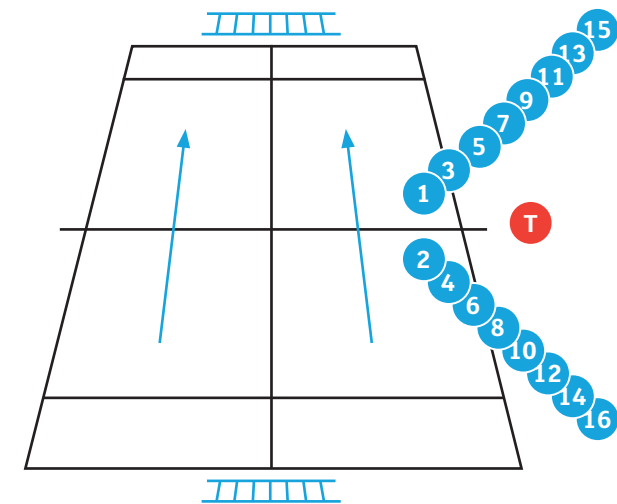

WARM-UP ACTIVITY

Grab and Go



- Players partner up across the net from one another at the service line.
- Hitters have a racket, their partner has a foam ball.
- Partner throws the ball underarm to hitter so can hit the ball off a bounce.
- Hitter plays shot cooperatively so feeder partner can catch the ball – both players are moving forward as this is happening.
- Both players meet at net and exchange the ball and racket, then they pedal back to the service line and repeat.
- Players on the baseline do star jumps until high fived by previous pair and swap over.

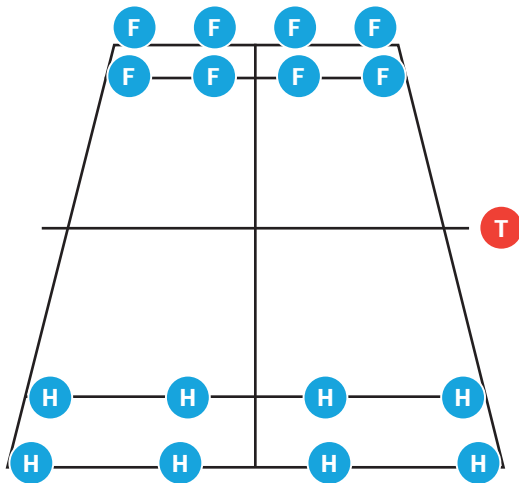

WARM-UP ACTIVITY

Three Volley Across



- Feeders feed from behind the service line.
- Feeders partners is ready to quickly take their place.
- On opposite side hitters approach the net, splits step and takes first volley then move to the right to receive second volley and the third. Hitters then move through ladder and rejoin line.
- After each feed, feeder swaps with their partner and run to collect a ball ready for next go.

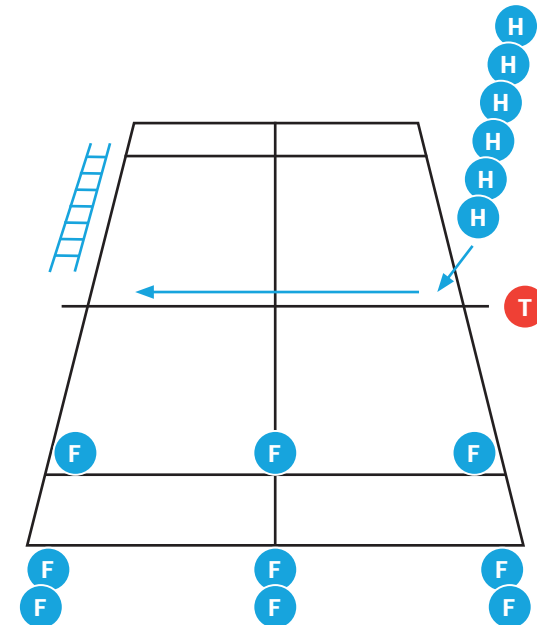

WARM-UP ACTIVITY Feel the Rhythm



- Players are spread out on both baselines facing the net, racket in hand.
- Teacher is in front of the players, facing the net as well.
- Teacher demonstrates as players follow, high knees to the net then split step.
- Turn around, run to the baseline with back kicks then split step, get in rhythm with the music!

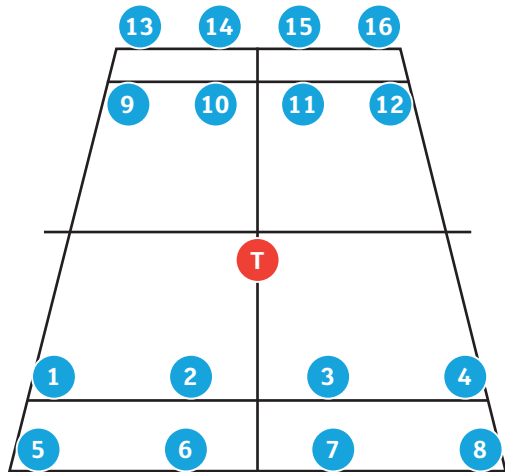

WARM-UP ACTIVITY Murray Go Round



- Players form two big circles, ball in hand.
- Upon the teacher's direction, all shuffle clock wise to the music.
- The teacher then calls out 'change direction' and gives commands for players to throw and catch balls without a bounce (volley), with a bounce (groundstroke), or pass to the player behind (lob).

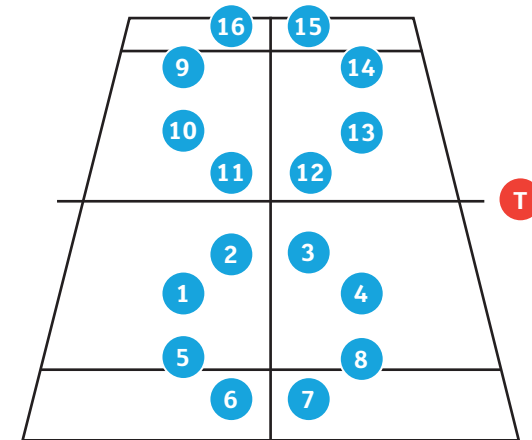

WARM-UP ACTIVITY Sharapova Shuffles



- Players start in service box, racket in hand.
- On teachers command players shuffle sideways touching sideline and centre line alternatively for 30 seconds.
- Variation: at the end of the warm up you can make it a competition counting who can touch the most lines in 20 seconds.

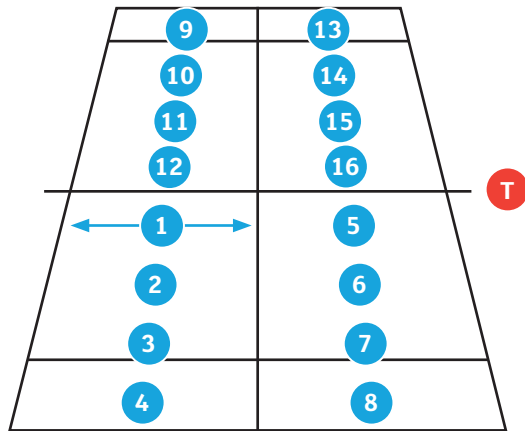

WARM-UP ACTIVITY Jumping Djokovics



- Teacher and players are spread out on one side of the court.
- They all do jumping jacks to the music.

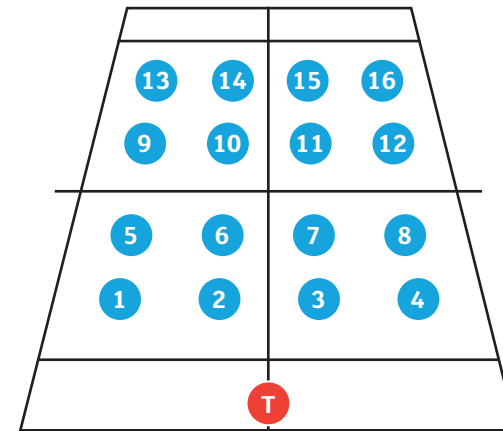

WARM-UP ACTIVITY

Free Style Swim



- Teacher and players are spread out.
- They all do big arm circles imitating a free style swimmer to the beat of the music – work for 30 seconds.
- Variation: see which of your pupils has the coordination to have one arm circling forwards and one arm backwards.

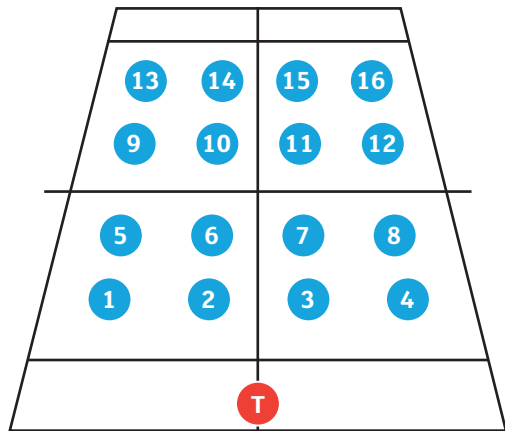

WARM-UP ACTIVITY

Drop Shot Djoks



- Feeders run to throw down spot and feed a short ball with hand or racket, then move off court through ladder.
- Hitters run to retrieve drop shot.
- Hitters then move off the court, through ladders.

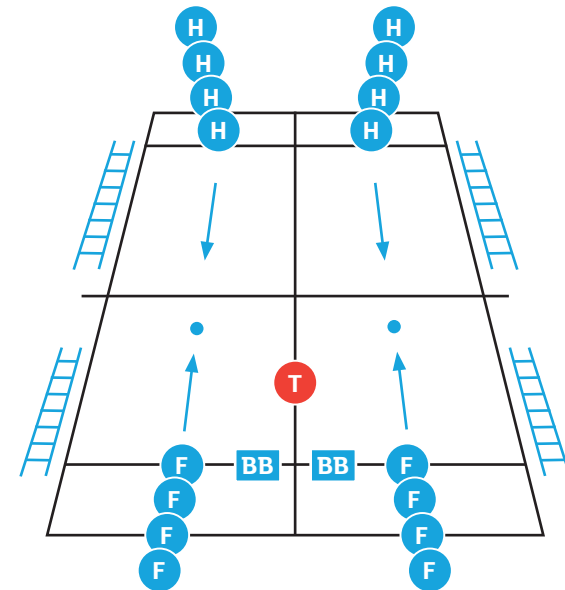

WARM-UP ACTIVITY Ladder Circuits



- Players jog around the court and do variety of activity on teachers command e.g. sideways through ladders, hop on one leg, etc.
- Players work for 30 seconds intervals

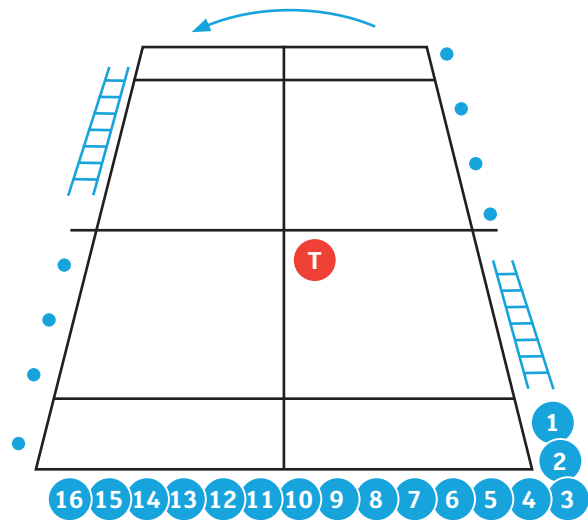

WARM-UP ACTIVITY Team Switch



- Players jogging on the spot in front of different coloured throw down spots / cones.
- Teachers calls out colours and the lines switch by side stepping.

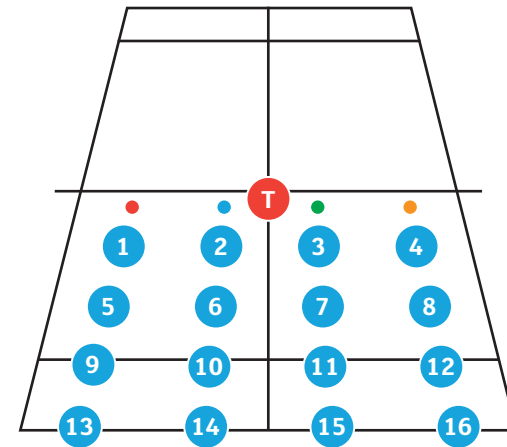

WARM-UP ACTIVITY

Steal



- Players spread out on court and start with four balls on each racket placed on the floor.
- On teachers command, players steal balls from each others rackets (one ball at a time only).
- Aim is to get as many balls as possible working against the clock or could be first to six balls.

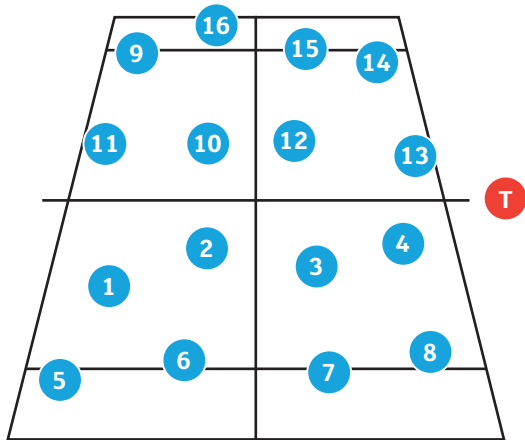

WARM-UP ACTIVITY

Throw and Go



- Players 1 and 2 throw ball to partner across net and jog switch to the opposite sideline. Players 3 and 4 follow and so on.
- Throw to partner should be with both hands, either on forehand or backhand side, or overhead.
- Players move through ladders back to starting sideline.

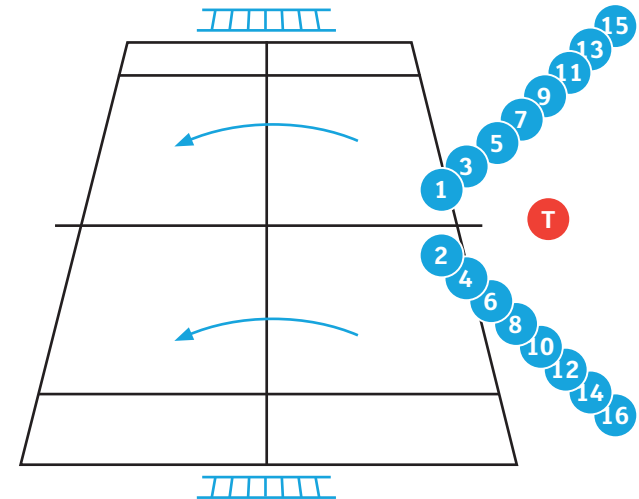

WARM-UP ACTIVITY Shadow Swings



- Players line up with adequate space between them.
- With rackets, players shadow hit on teachers command copying teacher's strokes e.g. forehand, backhand, volley, wide forehand, overhead smash, etc.

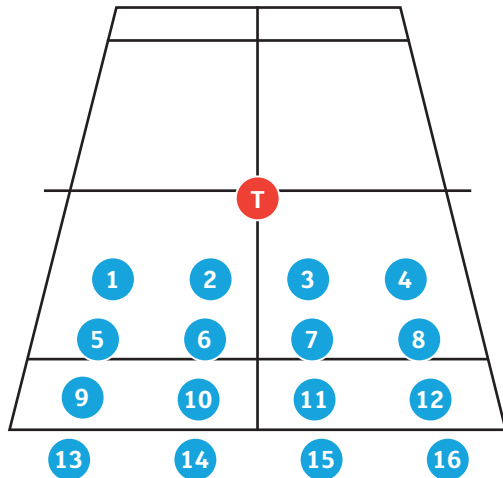

WARM-UP ACTIVITY Gladiators



- Gladiators with ball on their racket have to reach opposite sideline and put ball in bucket.
- If tagged by challenger players must swap racket and ball and new Gladiator starts from sideline.

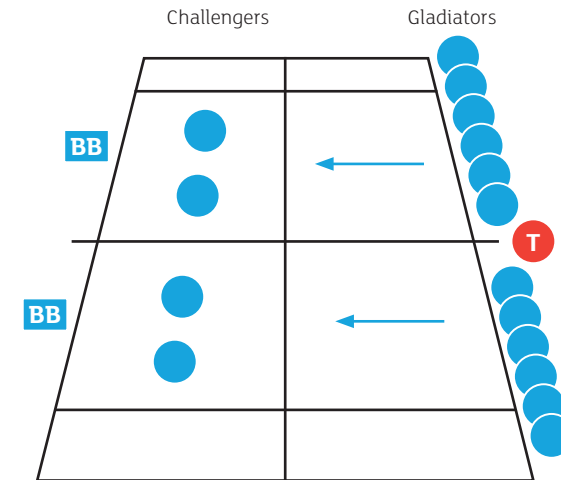

WARM-UP ACTIVITY

Sixties



- Place 12 throw down spots around the court. Players in pairs, spread out and stand in one of the twelve positions.
- On the teachers command, players have a rally of five before moving clockwise to the next throw down spot.
- Aim is to have a rally of five in each of the twelve positions.
- Winning pair are first to complete the circuit and shout 'SIXTIES!'.

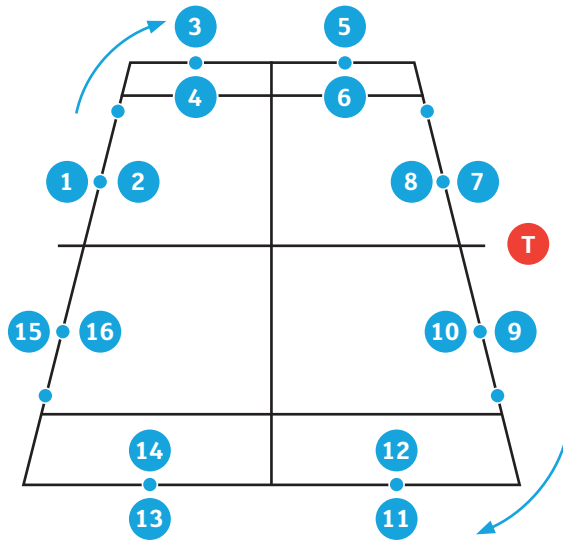

DRILL BASED ACTIVITIES

Double Volley



- Two lines of hitters, single file, as per diagram.
- Feeders feed two balls and must collect balls and join end of the line.
- Hitters hit two volleys, go through ladder and join other line.
- Variation: Players can also catch the ball rather than hitting.

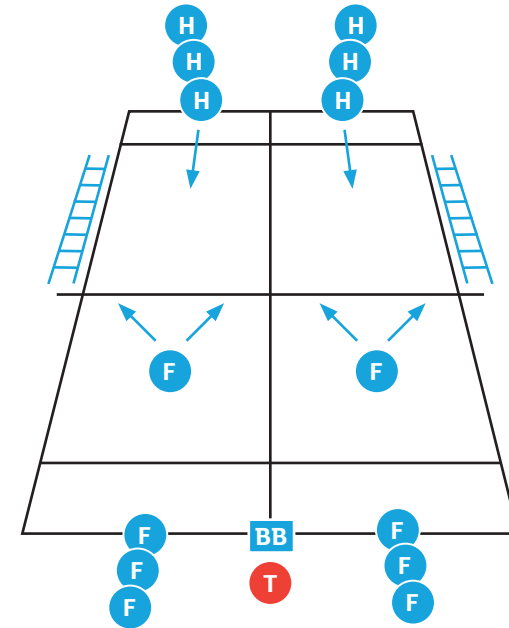

DRILL BASED ACTIVITIES

Two Balls Across



- Two feeders positioned in front of service line on one side of the court.
- On the opposite side, the hitters form a line on the left-hand side of the baseline.
- Hitter 1 is behind the baseline on the right-hand side and hitter 2 is behind the baseline on the left-hand side. Hitter 1 hits the first feed down the line and moves off the court to the end of the line. Hitter 2 hits the second feed down the line and moves to the position that hitter 1 vacated.
- Repeat feed, hitters 2 and 3 hit and rotate so that hitters 3 and 4 are in position for the next feed.
- Catchers catch at opposite end of court.

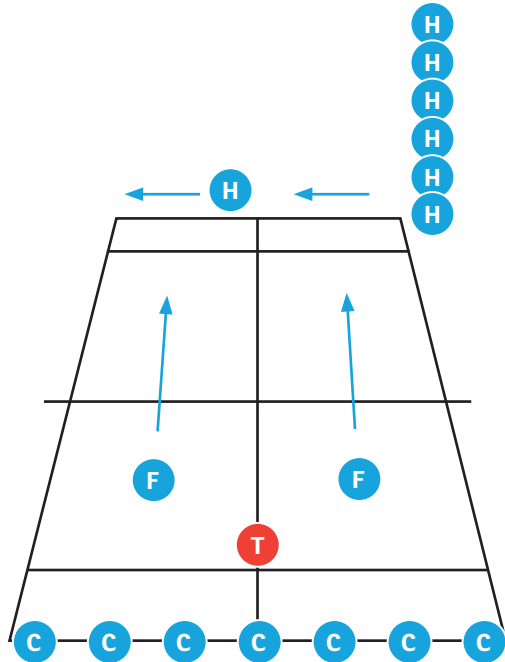

DRILL BASED ACTIVITIES

Serve and Volley



- Two lines of hitters starting from the baseline.
- Two lines of feeders on the opposite side of the court.
- Teacher counts '3, 2, 1 GO!' and first two hitters serve at the same time. They run to the net.
- Feeders feed two volleys.
- Players make volleys, move off court, go through ladder and go to the end of the line.
- Next two players repeat.

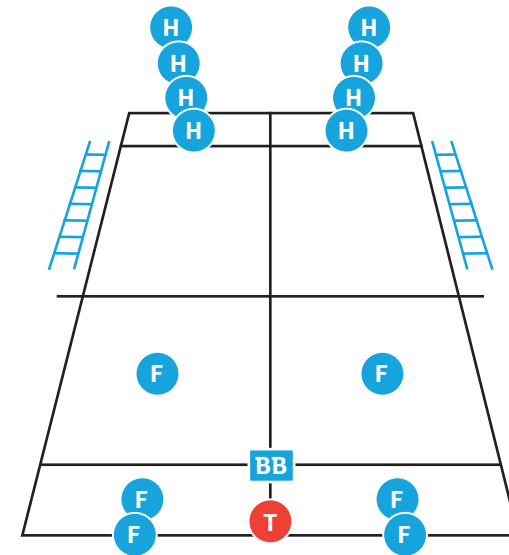

DRILL BASED ACTIVITIES

Put It Away



- Feeders feed two balls from the service line and high five next feeder.
- On the opposite side, hitters hit the first volley from the service line and run to the net hitting the second volley close to the net.
- Hitter then moves off court, moving through the ladder and joining the opposite hitting line.

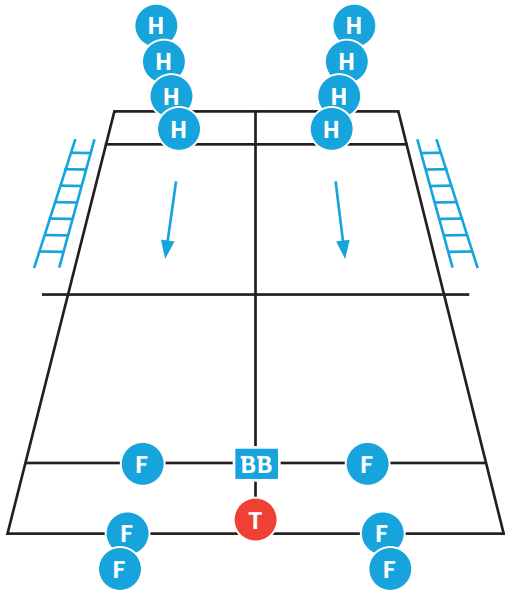

DRILL BASED ACTIVITIES

Go Get It



- Feeders feed a lob into the shaded area, as per the diagram and swap every two feeds.
- When its their turn the hitters must touch the net with their racket and run to retrieve the lob on feeders command from alternative sides.
- Players move through ladders and join the back of the line.

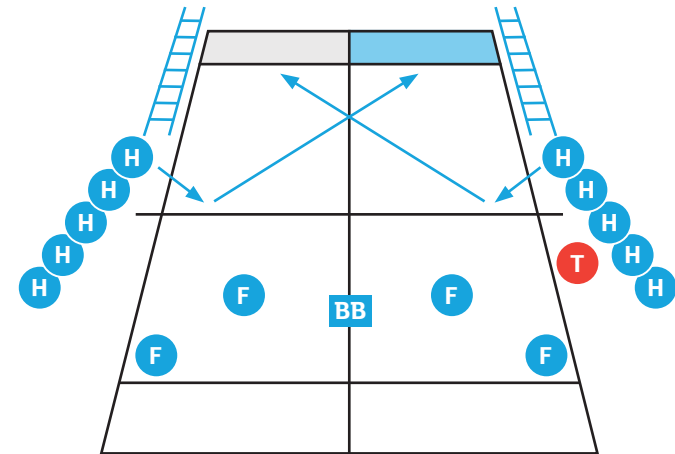

DRILL BASED ACTIVITIES

Mid Court Crusher



- Feeders feed a ball into air above shaded area, as per the diagram.
- Hitters move in and hit a drive volley before moving off court, through ladder and join opposite hitting line.
- Feeders must collect the ball from the other end.

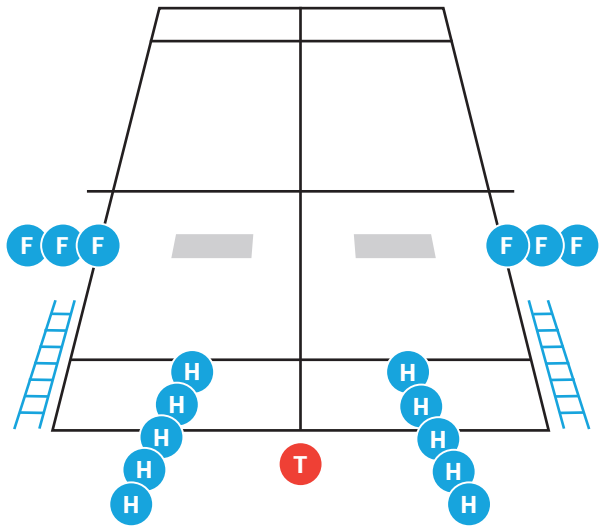

DRILL BASED ACTIVITIES

Approach and Volley



- Feeders feed one short ball to shaded area and then a volley.
- Hitters play shots and then move off court through the ladder.
- Feeder high fives next person in line who repeats. Feeders to collect balls.
- Players waiting should be doing side line activities.

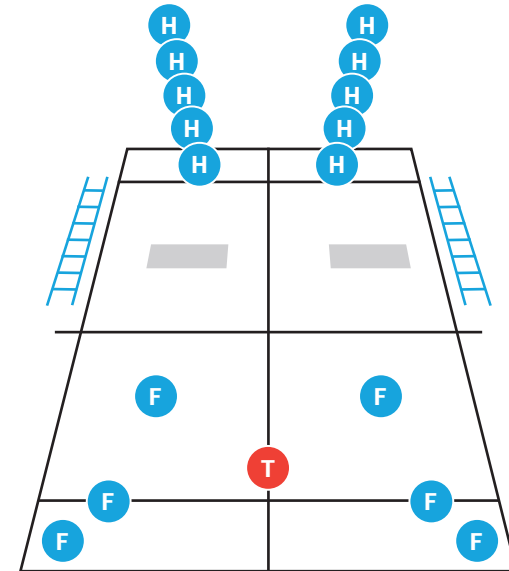

DRILL BASED ACTIVITIES

Federer's Field Day



- Two lines of hitters at the baseline.
- Two feeders on opposite side of the court (on the service line) without a racket.
- The first two hitters hit one shot then move off court, through ladders and switch lines.
- Catchers try to catch balls out of the air or off the first bounce.
- Once a catcher catches three balls they switch with the hitter whose ball was caught last.

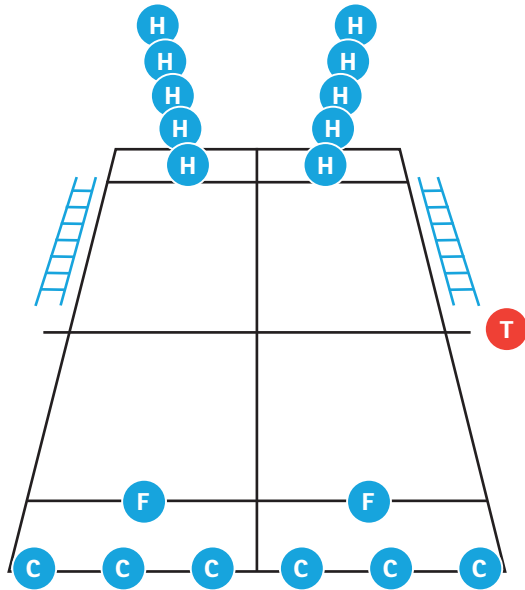

DRILL BASED ACTIVITIES

Three Volley Across



- Feeders feed from behind the service line.
- Feeders partners is ready to quickly take their place.
- On opposite side players approach the net, splits step and takes first volley then move to the right to receive second volley and the third.
- After each feed, feeder swaps with their partner and run to collect a ball ready for next go.

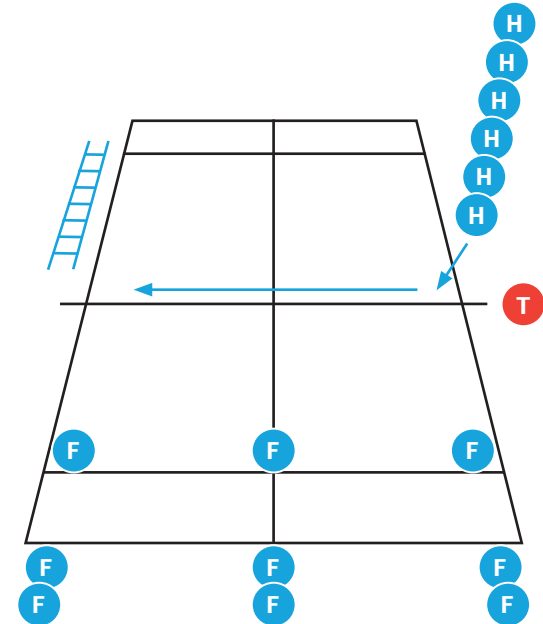

DRILL BASED ACTIVITIES

Scatter Gun Volley



- Two lines of feeders and hitters, as per the diagram.
- Feeders feed six to eight balls in quick succession to the hitter who hits backhand and forehand volleys, then move off court through ladder and join other line.
- Players off court collect balls ready to become feeder.

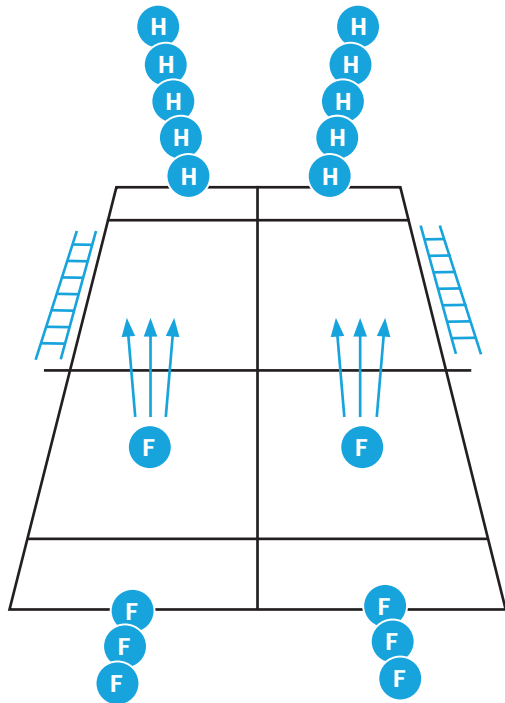

DRILL BASED ACTIVITIES

Deep and Drop



- Feeders feed two balls to the shaded area, as per diagram, one deep and one drop shot.
- Hitters hit first groundstroke just inside the baseline and move to the net to pick up the drop shot.
- Feeders and hitters then swap rackets and positions.

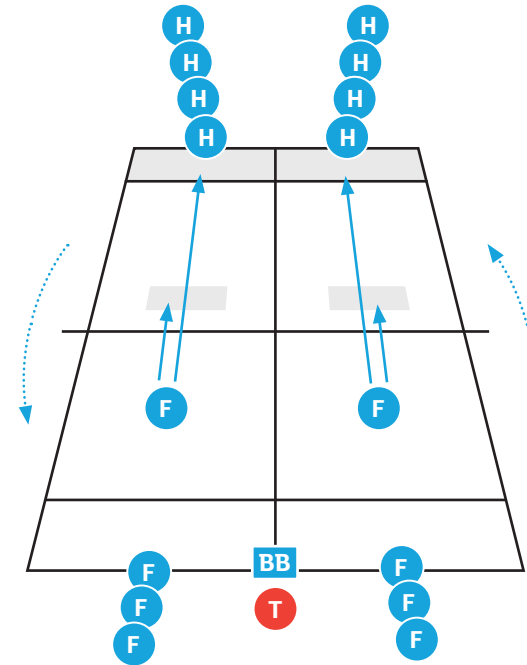

DRILL BASED ACTIVITIES

Serve and Go



- Two lines of hitters on the baseline. Catchers in two lines on opposite side of the court.
- First hitter, serves diagonally into the service box and catchers catch the ball.
- Players swap sides, going through ladders and pass racket to new hitter.
- Variation: if players struggle with serve, they can throw diagonally into service box.

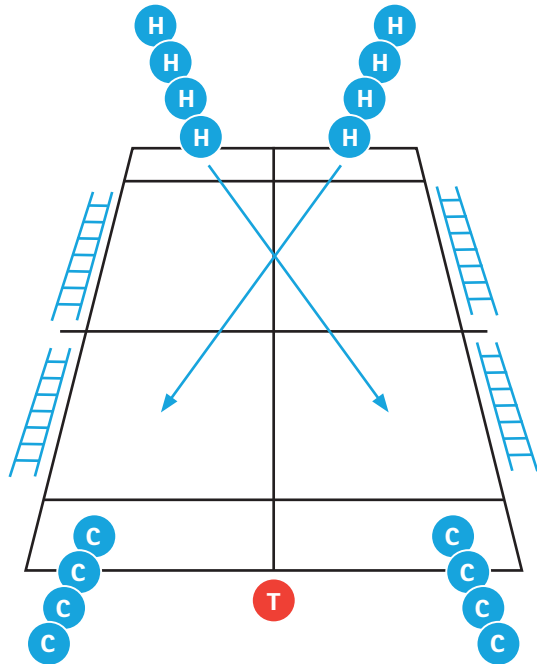

PLAY BASED ACTIVITIES

Capture the Net



- Balls are placed at the net on both sides. Aim of the game is to 'capture the net'.
- One side starts at the net and feeds in a ball to the hitters on the opposite baseline.
- If they win the point, they swap with the next pair in their team who run to the net, pick up a ball and feed to the opposite baseline pair.
- On losing a point the other team have captured the net and they feed to the next pair who are now on the baseline.

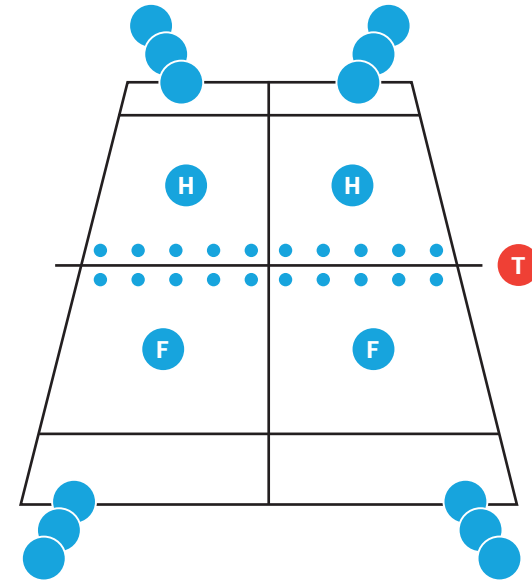

PLAY BASED ACTIVITIES

Build It



- Four players on court (1, 2, 3 and 4).
- Two players on each side at the baseline rallying down the line. Two balls going on at the same time.
- When a player misses he is replaced by player 5. The next player who misses is replaced by player 6 and so on. You'll constantly have players hitting to build a rally and players running around the court to find their turn on court.
- Players on sideline should be doing sideline activities.

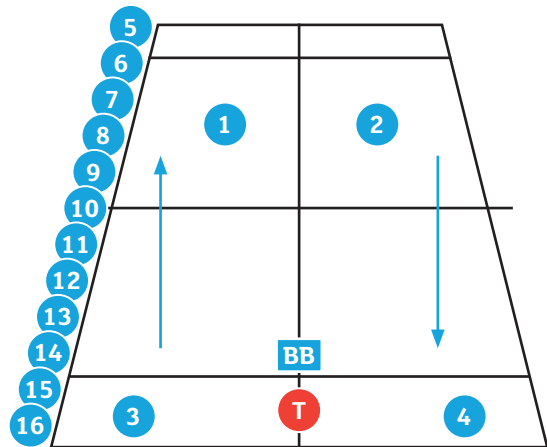

PLAY BASED ACTIVITIES

Charge!



- Teacher is free to walk around and give feedback. Ball bucket is placed close to the back fence, centred on player 1 and 2's side of the court.
- Two players at the other baseline on one side and other players in the back waiting doing sideline activities.
- Players play on half court straight ahead down the line so two balls are going on at the same time.
- Players 1 and 2 grab a ball from the ball bucket. Player 1 then feeds a deep shot to player 3 down the line. Both players finish the point up close to the net. Players 2 and 4 do the same on their side of the court.
- When a point is over the players rotate outside for the next players to come in.

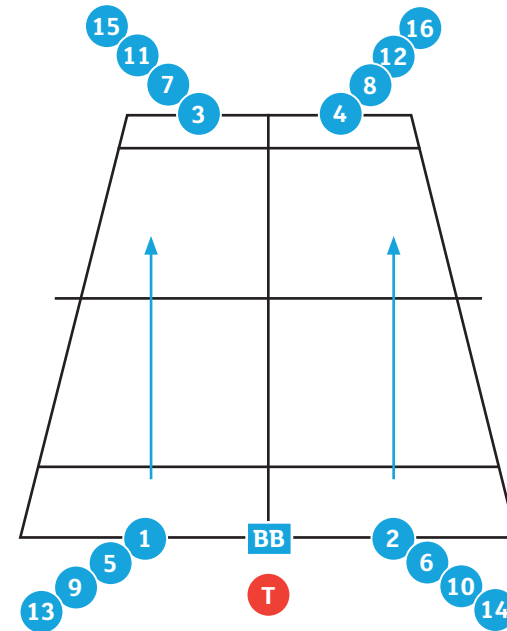

PLAY BASED ACTIVITIES

Net to Baseline



- Four players are on court and other players are doing sideline activities.
- Two baseliners 1 and 2, and two net players 3 and 4.
- The teacher is feeding to the baseliners from no man's land. Player 1 receives the feed from the teacher then plays the point out down the line with player 3.
- Player 2 receives and plays the point out down the line with player 4. As the points end, the teacher feeds the ball for continuous play.
- Three-four minute rotation then players 1, 2, 3 and 4 switch with the players who were doing sidelines activities. For the next rotation players 7 and 8 are at the net and 5 and 6 at the baseline.

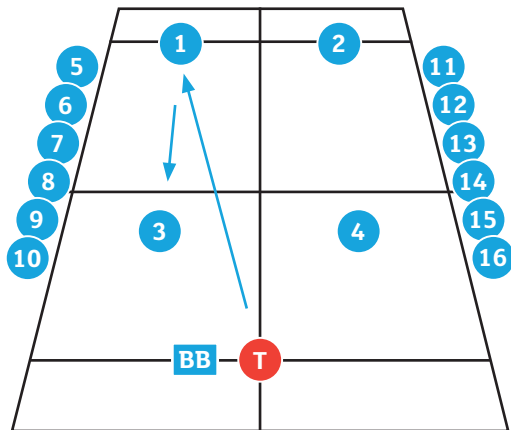

PLAY BASED ACTIVITIES

Triples



- Players start with one at the net and two at the baseline on each side of the court. As per diagram.
- Players play the point out and then rotate anti-clockwise to next position (all players involved i.e. 7 moves to position 1, 1 to 2, 2 to 3, 3 to 11 and so on). Good to practice rotation without the ball first.
- Teacher feeds one team the whole game, then switches the feed to the other team.
- Encourage players to backpedal from net to baseline rotation.
- Players off-court doing sideline activities.

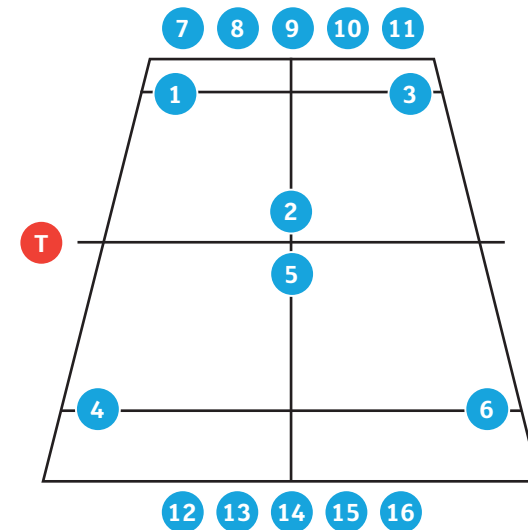

PLAY BASED ACTIVITIES

2 v 2



- Players start each point from the baseline then anything goes.
- Teacher can alternate feed from team to team or can feed one side the whole game.
- Whoever loses the point rotates out. Great for 10 or more players.
- Play points to seven or 11.
- Players waiting doing sideline activities.

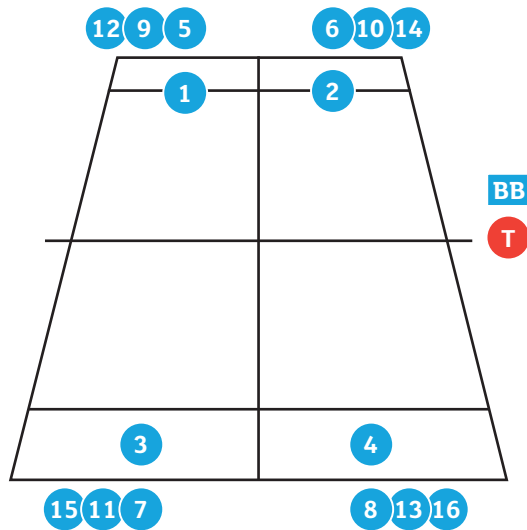

PLAY BASED ACTIVITIES

Drop Shot



- Teacher is on a side with ball bucket.
- One line at the centre of the baseline on one side, one line at the centre of the baseline on the opposite side.
- Teacher feeds a drop shot to player 1.
- Player 1 sprints to the net gets the drop shot and drop shots back.
- Player 2 runs to player 1's drop shot and the point starts. Play the point out.
- As 1 and 2 exit the court, teacher quickly feeds a drop shot to player 3 and so on.

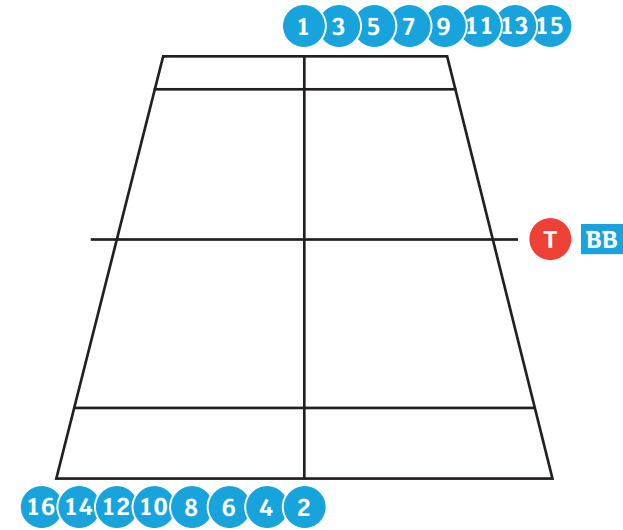

PLAY BASED ACTIVITIES

Half Court Serve and Volley



- Teacher is free to move about, the ball bucket is centred at the back fence.
- Receivers on one side, hitters on the other.
- Hitters serve straight ahead and avoid serves towards the T because receivers may run into each other.
- Hitters serve and volley on half court and play the point out. Any time a hitter loses, they get a ball from the ball bucket and wait their turn to serve on the other half of the court.
- If a hitter wins a point, they get to play a second point. On winning two points, the hitter takes the place of the receiver they won the second point from.

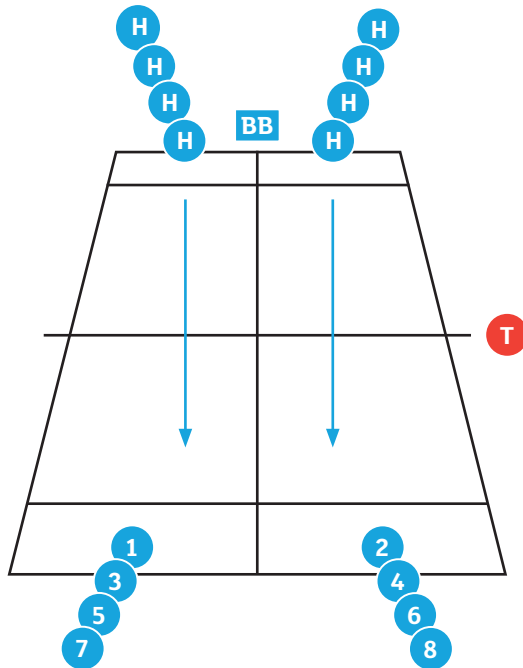

PLAY BASED ACTIVITIES

RAFA Recovery



- Players doing sideline activities.
- Players on court hitting back and forth down the line.
- A target, such as a round sport is placed at the centre mark at the baseline on both sides of the court.
- Players are to recover to the target between each shot.
- Players come off when rally breaks down or after designated number of goes.

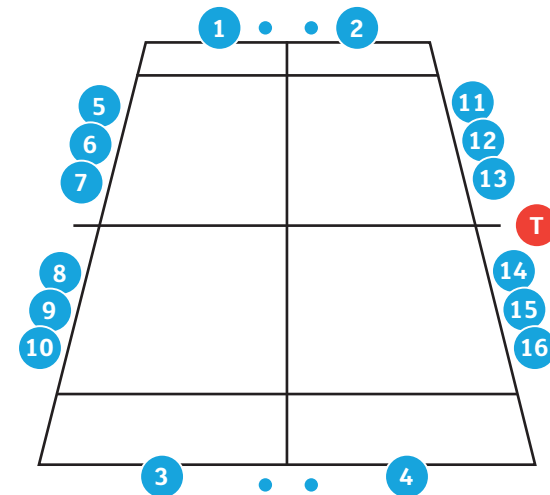

PLAY BASED ACTIVITIES

Adios!



- The teacher feeds from behind the service line in the centre of the court.
- As soon as the point begins the four players move forward and the point is played in a reflexive volley style.
- When a player makes a mistake they have an 'error'.
- Two errors and 'adios!', that person moves off court and the person waiting at the net post jumps in and takes their place. Everyone goes back to zero.
- Players waiting doing sideline activities.

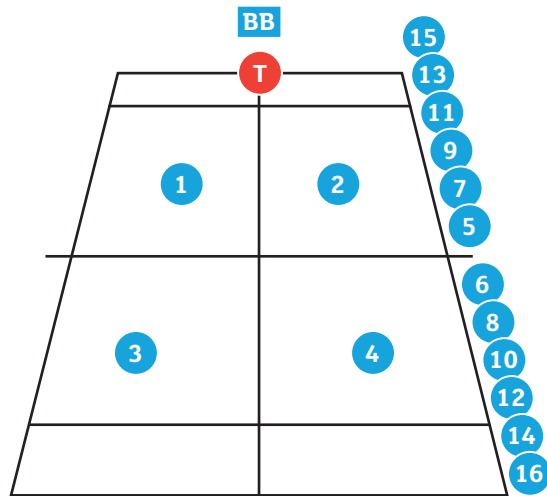

PLAY BASED ACTIVITIES

Rainmaker



- Two teams either end of court with first player ready on court.
- Teacher positions themselves on one side of court and feeds to player on opposite side.
- Players play out the point.
- Player that wins the point stays in and plays a second point. Players only stay on for a maximum of three points.
- Player that loses goes to end of the line and next player steps in.
- First team to 10 points wins.

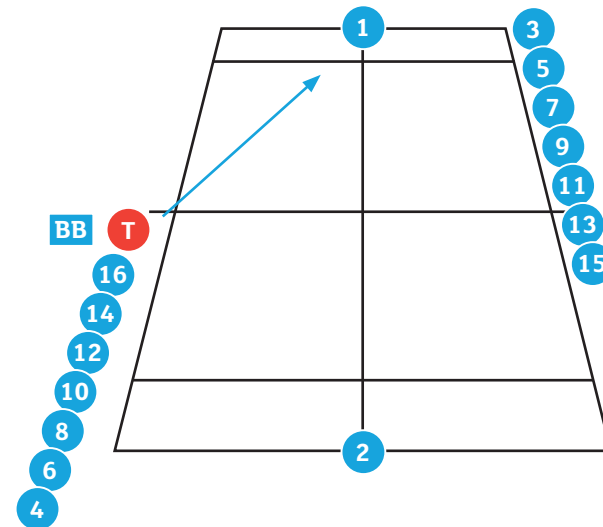

PLAY BASED ACTIVITIES

Up and Over



- Two rows of players each face off across the net standing just behind the service line.
- Players hit the ball so that it will first bounce in front of the player that they are hitting to.
- Receiver then bounces the ball up so that it will bounce on the court in front of them before they hit the ball back.
- When rally breaks down players run to back of court and swap positions.
- Players waiting doing sideline activities.

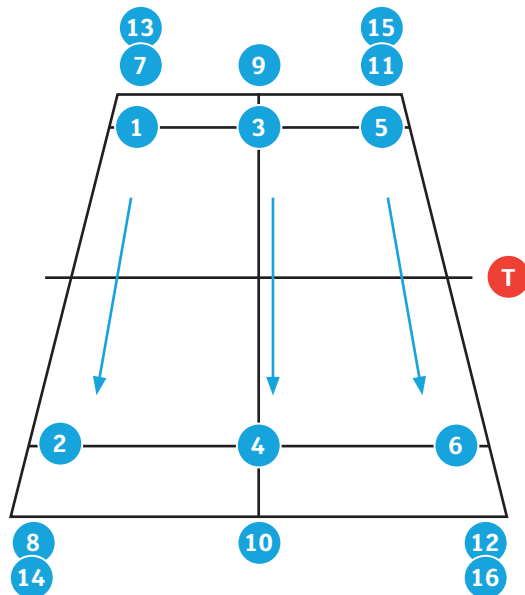

PLAY BASED ACTIVITIES

Champs And Challengers



- Game can be played as singles or doubles with 'Champs' on one side and 'Challengers' on the other.
- Teacher feeds to the challengers. The point is played out and anything goes.
- Play one point at a time.
- If champions win the point they stay in the game and play against new challengers.
- If challengers win the point they run to champs end and take their place.
- Players waiting doing sideline activities.

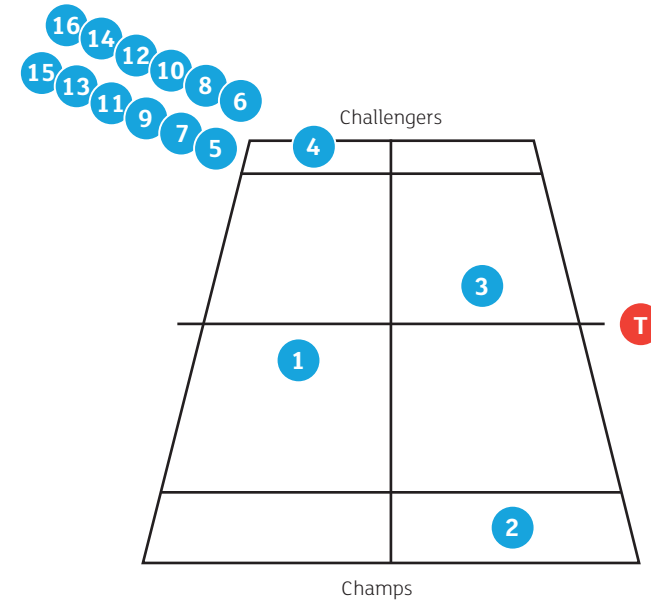

PLAY BASED ACTIVITIES

CO-OP Volley



- Players stand across the net from one another about a metre inside the service line close to the sideline.
- They cooperatively reflex volley the ball as they both move to the opposite sideline.
- When they get across the court move through ladders and go to the end of the line and repeat.

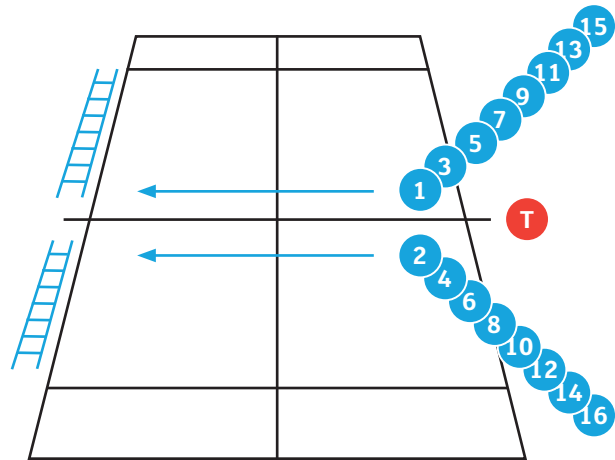

PLAY BASED ACTIVITIES

Thigh Burner Volleys



- This is a cooperative drill. Six players on court at the service line. Teacher is free to move around.
- Feeders on one side feed straight ahead to receivers..
- Receivers approach the net to volley, back pedal to service line and split step ready to move forward for the next volley.
- Players work for thirty seconds and swap with waiting players.
- Players waiting doing sideline activities.

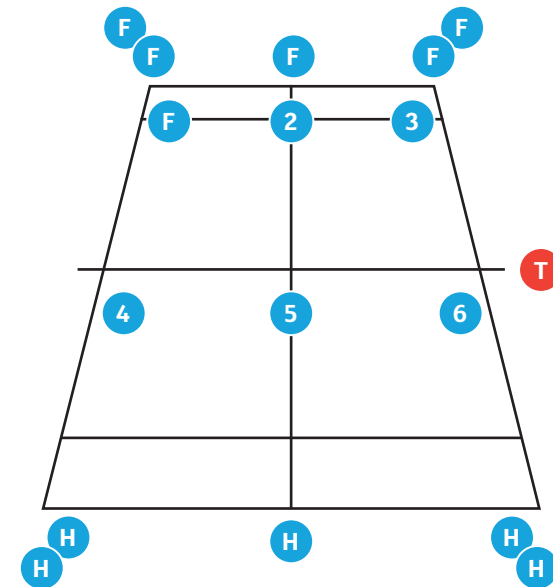

PLAY BASED ACTIVITIES

Star Wars



- Teams start on opposite ends of the court in a single file line.
- Teacher feeds ball and a single point is played between first players in each team.
- Whoever wins the point gets to stay in and bring in a team mate.
- The player who loses the point goes to the end of the line and a new teammate takes their spot.
- Now it's 2 v 1.
- When the whole team is on the court and wins, they score a point.
- After scoring all players exit and the last player in starts the next point.

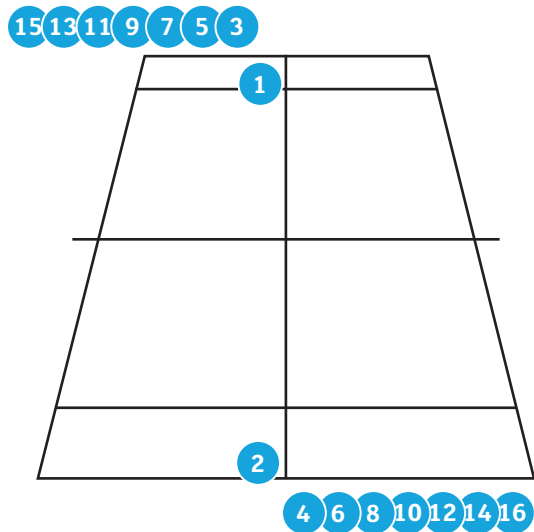

PLAY BASED ACTIVITIES

I Did It!



- Two champions on one side of the net play point against challenger on other side of the court at the same time.
- Challengers play one point, win or lose and rotate out to back of line.
- When a challenger wins a total of three points they yell: "I did it!" and take the champions spot that they won the third point from.

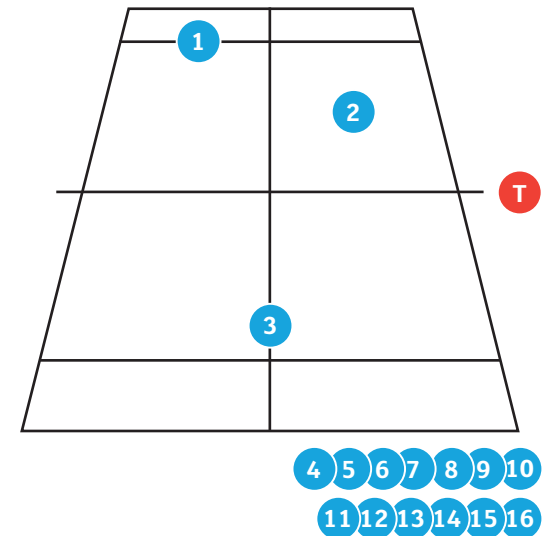

COOL DOWN ACTIVITIES

Consistency Volley



- Two lines down the middle with first player standing between the net and the service line.
- Feeders on the opposite side of the net, feed to first player in each line.
- Can use a spot on the court where the players are starting the line.
- Players hit one volley back to the feeders then quickly rotate off court through ladder. Next hitter then joins rally with feeder and so on.
- Feeders swap when rally breaks down.

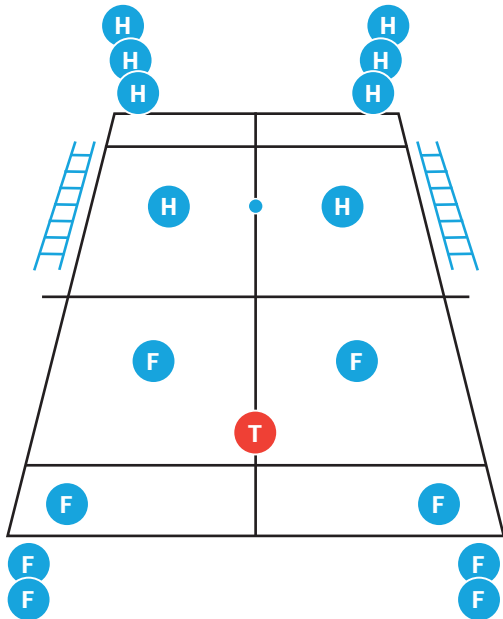

COOL DOWN ACTIVITIES

Partner Volley



- Cooperative reflex volley activity with partner.
- Great for six to eight players, can do anti-clockwise rotation every few minutes for variety and movement.
- Variation: you may have players both move to the net and then back to service line without stopping the activity.
- Players waiting doing sideline activities.

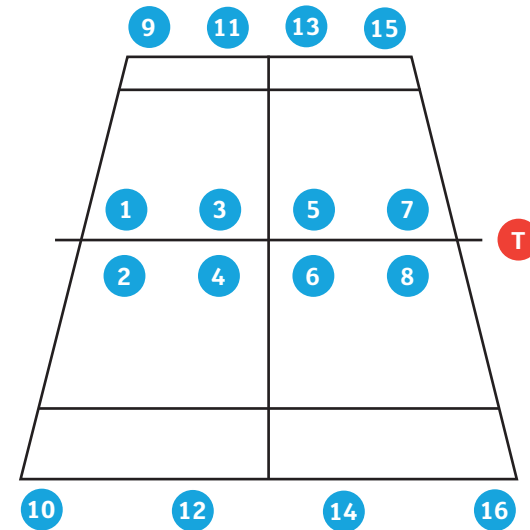

COOL DOWN ACTIVITIES

Service with a Smile



- Four players spread out on the baseline, four players getting balls out of the ball bucket.
- Teacher can use spots on the court to determine each players' position for their serves. Can also use targets for servers to hit.
- Each player serves three balls (with a smile!) then rotates out to retrieve balls, leaving room for next four players to serve.

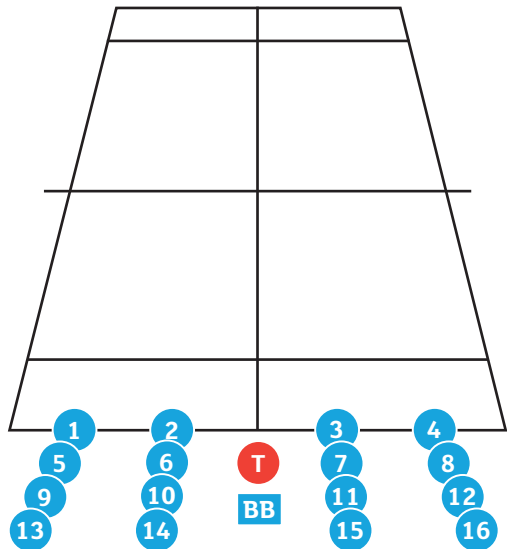

COOL DOWN ACTIVITIES

King of the Court



- A serving doubles team and a receiving doubles team. Receivers are king.
- Player 1 serves from the deuce side and plays the point out with their partner in doubles. Then player 1 plays another point from the ad side.
- The serving team has to win two points to replace the kings. If the score is 1-1 after the first two points then player 1 serves a 3rd point. If the serving team loses two points they get back in line.
- Players 3 and 4 come and take their turn. Alternate servers for the points to come. First receiving team to win 15 king points, wins.

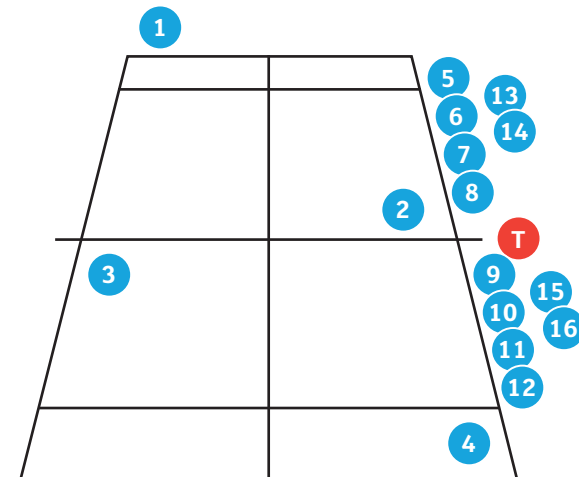

COOL DOWN ACTIVITIES

Tiebreaker



- If you have access to two courts have all players split into doubles teams and play a tiebreaker of doubles.
- If you are on one court, play a tiebreaker with four players on court and alternative teams every two points.
- Winning teams can then play against each other until overall winning team found.

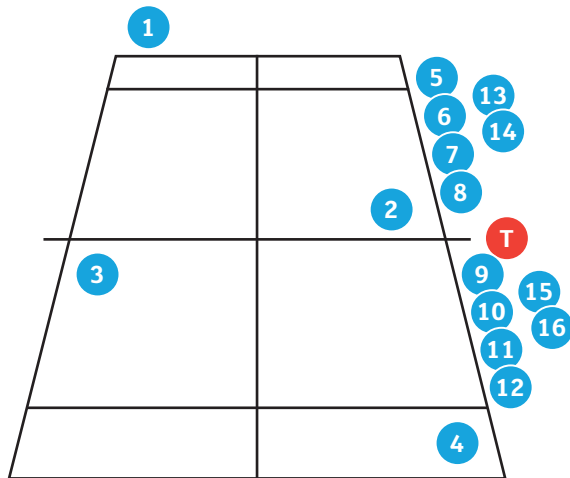

COOL DOWN ACTIVITIES

Team Serving



- Two teams of at least four players start at the baseline in a single file line. One team in position to serve to the deuce court, the other team in position to serve to the ad court.
- The ball bucket is located in no man's land. Each team has a pile of seven balls on the sideline as far back as no man's land.
- Teacher starts the game. The players serve one at a time. If the player makes the serve, they get to get a ball out of the pile to give to their team mate for the next serve. If they miss they get the ball out of the ball bucket.
- Aim of the game is to eliminate your pile of balls first and your team wins.

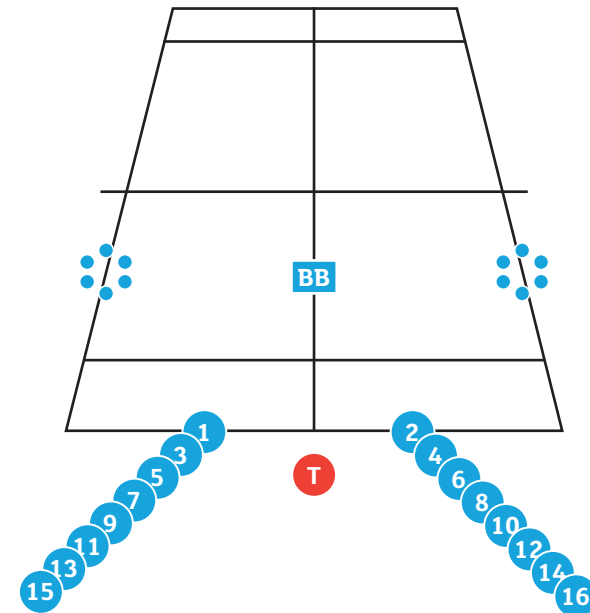

COOL DOWN ACTIVITIES

10, 10, 10



- Players in pairs stand close together and have a touch rally of 10 shots.
- They then find another partner and repeat again.
- Once they have had three rallies of 10 shots they shout '10, 10, 10!'.
- Variation: can be played using ground strokes or volleys.

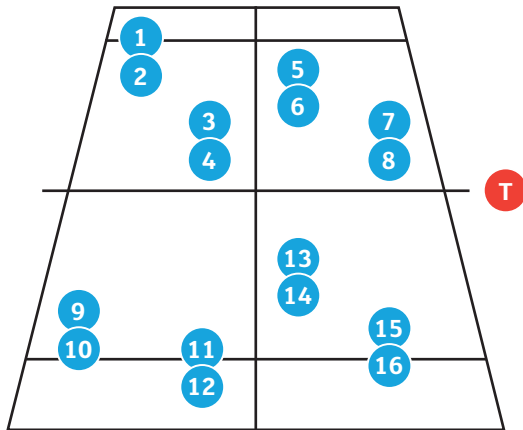

COOL DOWN ACTIVITIES

Volleyball



- Even teams on each side of the net.
- Players must pass the ball to their team, but no more than 3 times before hitting the ball over the net.
- Players can only hit ball upwards i.e. no smashing.

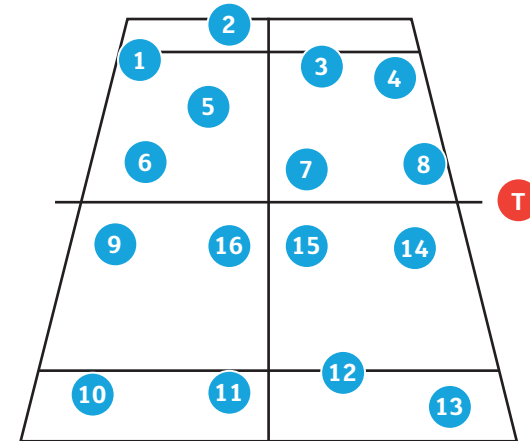

CARDIO TENNIS LESSON PLANS

A series of lesson plans have been included, which provide the content and structure for a 6 week block of activity. Each lesson plan contains warm-ups, drill based activities and play based main theme activities, finishing with a cool down.

Lesson 1

Warm Up

- Harlem Shuffle
- Hit & Move
- Grab & Go

Drill Based

- Two Balls Across
- Federer's Field Day

Play Based

- Up and Over
- Build It
- Champs And Challengers

Cool Down

- 10, 10, 10

Lesson 2

Warm Up

- Team Switch
- Harlem Shuffle
- Steal

Drill Based

- Double Volley
- Approach and Volley
- Scattergun Volley

Play Based

- Thigh Burner Volleys
- Bryan Brothers Cooperative Rally
- Charge!

Cool Down

- Volleyball Tennis

Lesson 4

Warm Up

- Feel The Rhythm
- Sharapova Shuffles
- Three Volleys Across

Drill Based

- Put It Away
- Mid Court Crusher

Play Based

- Drop Shot
- Capture the Net

Cool Down

- Partner Volley

Lesson 5

Warm Up

- Jumping Djokovics
- Freestyle Swim
- Drop Shot Activity

Drill Based

- Deep & Drop
- Go Get It

Play Based

- I Did It!
- Charge!
- Adios!

Cool Down

- Service With a Smile

Lesson 3

Warm Up

- Throw and Go
- Murray Go Round
- Shadow Swings

Drill Based

- Ball and Racket Exchange
- Two Balls Across

Play Based

- Recovery Channel
- Two Back vs Two Back
- Triples

Cool Down

- Doubles King of the Court

Lesson 6

Warm Up

- Ladder Circuits
- Gladiators
- Sixties

Drill Based

- Serve and Go
- Serve and Volley

Play Based

- Thigh Burner Volleys
- Capture the Net
- Half Court Serve and Volley

Cool Down

- Team Serving

▶ Playing

TRADITIONAL TENNIS

This says what it is really...but don't think full court, full sized rackets and yellow balls is the only option – you might find reducing the court size, introducing shorter rackets and low compression balls makes the experience more accessible for young people of all ages and ability levels.

'Ready to go' lesson plans

A series of lesson plans providing the structure and content for 6 lessons, using the traditional method of delivery on tennis courts.

'Mix and match' activity cards

You can mix and match these activity cards to develop your own lesson plans and to help provide some additional ideas for activities. Most of the activities included on the 'mix and match' activity cards can be adapted to cater for Short Tennis or traditional tennis delivery.

TENNIS XPRESS

Tennis Xpress is a six week coaching programme recently launched by the LTA for adult beginners, but it could easily be adapted for a teenage audience aimed at developing basic skills and game play. Tennis Xpress is delivered on traditional tennis courts, using low compression balls to help participants develop their skills and it encourages them to play the game from week one - learn how to serve, rally & score.

A new resource is being produced to support coaches in delivering Tennis Xpress.



More info...

- More information on Tennis Xpress can be found online at: www.lta.org.uk



Design Your Club



Let the young people make their own decisions around what format of tennis they want to play – try to have a selection of rackets of difference sizes, range of balls sponge/red/orange/green/yellow, Mini Tennis nets and let them choose what size of court they feel confident playing on.



Ready to Go

TRADITIONAL DELIVERY LESSONS PLANS: 1-6

- **Lesson One** 143
Game Situation Topic: Both Back
Tactic Topic: Consistency
Skill Topic: Groundstrokes

- **Lesson Two** 149
Game Situation Topic: Both Back
Tactic Topic: Consistency
Skill Topic: Groundstrokes

- **Lesson Three** 155
Game Situation Topic: Serve and Return
Tactic Topic: Over and In
Skill Topic: Serve and Return

- **Lesson Four** 161
Game Situation Topic: When Approaching or at the Net
Tactic Topic: Over and In
Skill Topic: Volley

- **Lesson Five** 167
Game Situation Topic: When Opponent is at the Net
Tactic Topic: Over and In
Skill Topic: Lobbing

- **Lesson Six** 173
Game Situation Topic: Doubles Play / Competition



WARM-UP ACTIVITY

Widths

L1

- Pupils jog from tram to tram with arms circling, sidestepping, crossover steps etc.
- Pupil to split step at each end.
- Teacher to reinforce running technique and introduce split step.

QUALITY POINTS

- *Keep your balance by leaning forwards slightly when jogging backwards.*
- *Do a split step at each end.*

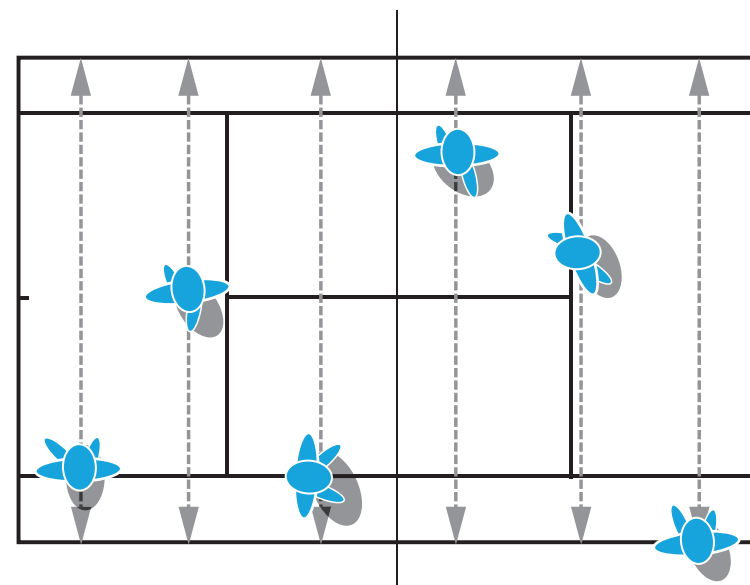

WARM-UP ACTIVITY

Target Tennis

L1

- Players place several cones about 1m from either side of the net.
- Players rally aiming to hit the others cones.
- They collect the cones they hit.

QUALITY POINTS

- *Balanced alert ready position.*
- *Angle the racket face to the target.*
- *Increase the path of the push to get the ball to go further.*

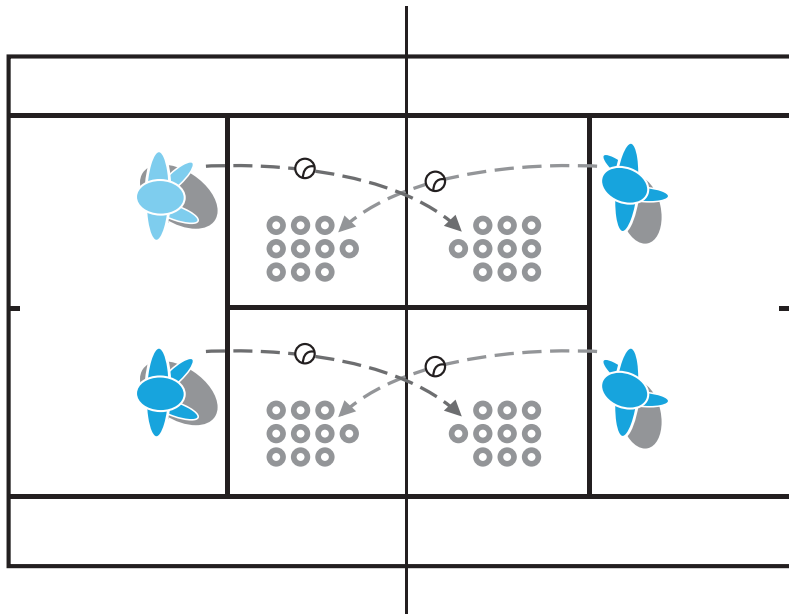

Main Theme One

L1

PLAYERS

- Hitter, Feeder, Collector - each player to hit 10 forehands and 10 backhands from the baseline and swap.
- Teacher to demonstrate forehand and backhand down the line.

SAFETY POINTS

- Some players may need to be closer to the net.

QUALITY POINTS

- *Balanced ready position.*
- *Unit turn.*
- *Low to high swing.*
- *Point strings in the direction of the target area (down the line).*

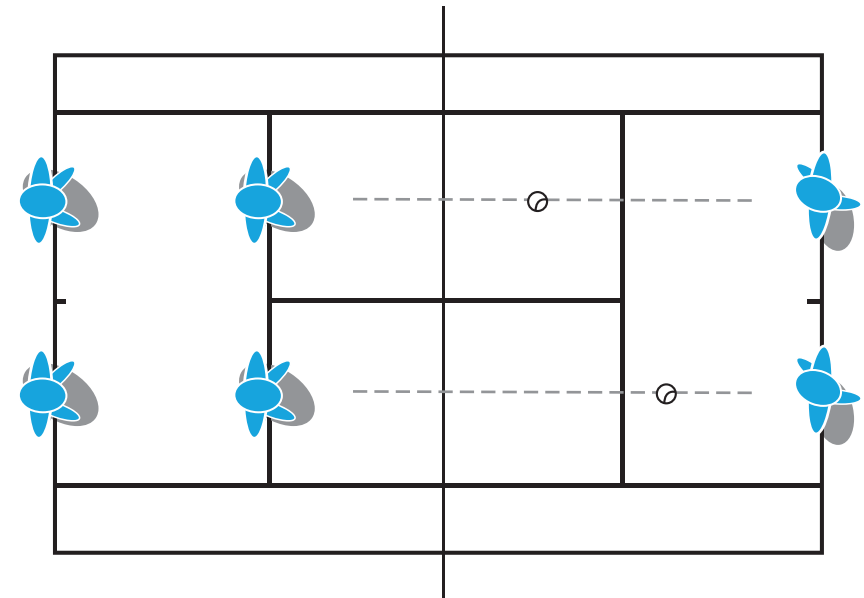

Main Theme Two

L1

PLAYERS

- Two players - working on one half of the court.
- Three players - working on half a court. Two at one end, rotate after each rally, player at the other end stays on.
- Four players - as per diagram.
- Five players - as per diagram with 5th player at the side of the court skipping. All players rotate one place to the left at the end of the rally.
- Six players - two groups of three. One player by themselves the other two at the other end, the two players rotate after each rally.
- Eight players – as per diagram with a waiting player behind each hitter, rotate after each rally.

SAFETY POINTS

- With more than two players use cones to mark out safe area at the back of the court for waiting players.

ACTIVITIES

Stage 1: Co-operative Activity

- Player 1 feeds ball underarm to Player 2 and counts length of the rally.
- Using half the court including the tramlines.
- Players 3 & 4 rally on other half of court (see picture).

Stage 2: Competitive Activity

- Rally of four and play out the point.

QUALITY POINTS

- *Control racket path in a straight line.*
- *Stabilize wrist position with a contact point in front.*
- *Long hitting zone to control direction.*
- *Play the ball deep by aiming higher over the net.*

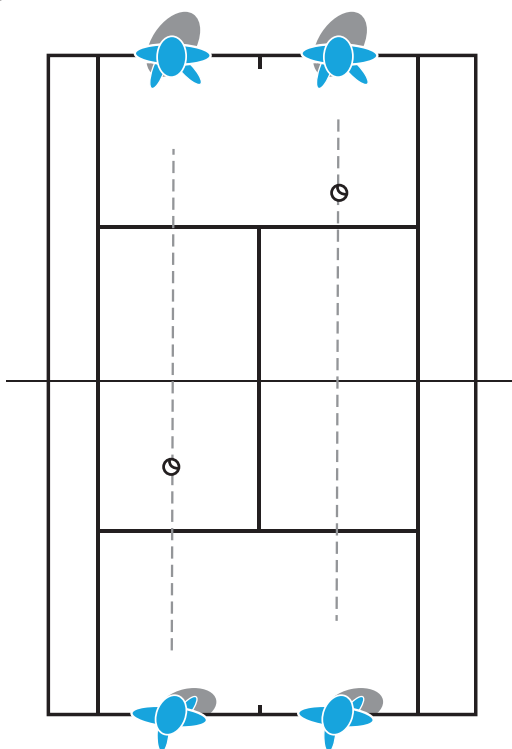

Main Theme Three

L1

PLAYERS

- Two players - working on one half of the court.
- Three players - working on half a court. Two at one end, rotate after each rally, player at the other end stays on.
- Four players - as per diagram.
- Five players - as per diagram with 5th player at the side of the court skipping. All players rotate one place to the left at the end of the rally.
- Six players - two groups of three. One player by themselves the other two at the other end, the two players rotate after each rally.
- Eight players – as per diagram with a waiting player behind each hitter, rotate after each rally.

SAFETY POINTS

- With more than two players use cones to mark out safe area at the back of the court for waiting players.

ACTIVITIES

Stage 1: Co-operative Activity

- Player 1 feeds the ball in underarm to Player 2 and counts the length of the rally trying to keep the ball past the service line.
- Using half the court including the tramlines.
- Players 3 & 4 rally on other half of court (see picture).

Stage 2: Competitive Activity

- Rally of 4 behind the service line and play out point.

QUALITY POINTS

- *Control racket path in a straight line.*
- *Stabilize wrist position with a contact point in front.*
- *Long hitting zone to control direction.*
- *Play the ball deep by aiming higher over the net.*

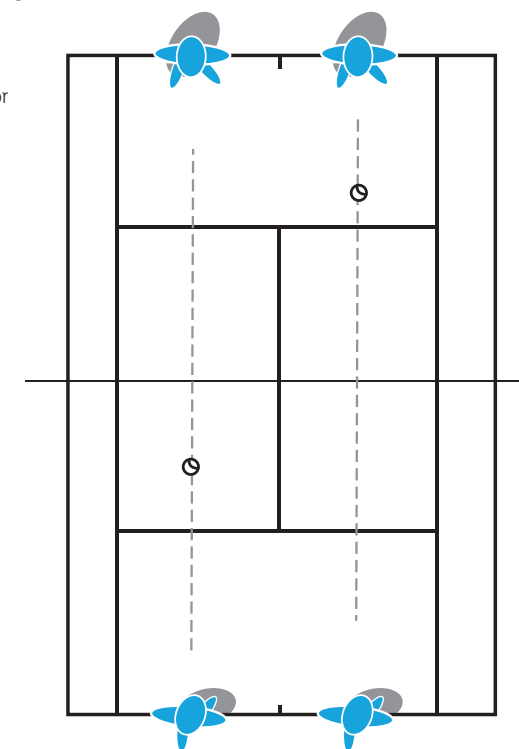

COMPETITION *Both Back*

L1

HARD ACTIVITY

- Players must prevent their opponent from stepping into the court area.
- One or both players must stay inside the baseline and take the ball early to take time away from their opponent.
- Players must rally keeping the ball past the service line.
- Differentiation - One player must hit past the service line, the other can hit anywhere in the court.

EASIER ACTIVITY

All practices can be made easier by using green, orange or red balls.

- Player 1 feeds ball in from baseline and the ball may bounce twice inside the court area.
- Battleships - Each player has five cones placed close to the net on their half of the court. Players rally aiming for their opponent's cones. The player who hits a cone, then wins it and must place it on their side of the court. The winner is the player with the most cones.
- One player feeds and the other hits.
- Both players throw and catch.

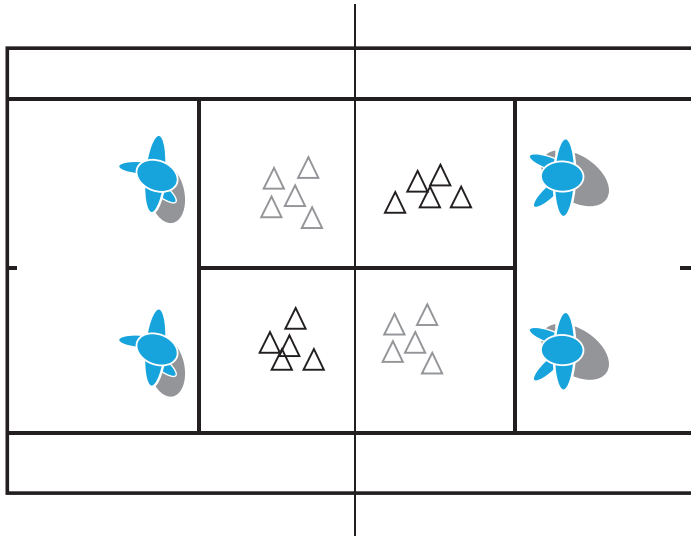

WARM-UP ACTIVITY *Throw and Go*

L2

- Players line up behind a marker and use a variety of throws to pass the ball to the player in front.
- The thrower then runs to the end of the receivers' line.
- Using both hands throw forehand side, backhand side, overhead throw.
- Stop and balance before throwing, keep head and shoulders still, follow through with arms in front.

QUALITY POINTS

- *Keep your head up to watch your partner as well as the ball.*
- *Have a balanced base and light footwork.*

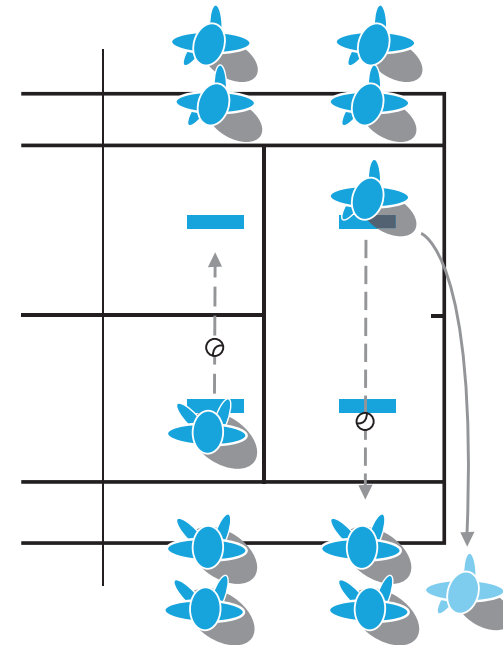

WARM-UP ACTIVITY

Step Back Rallies

L2

- Players start close to the net hitting forehands and backhands.
- With each successful hit they take a step backwards until they reach the baseline.
- Point strings in the direction the ball is intended to go.
- Turn sideways for forehands and backhands.

QUALITY POINTS

- *Get the racket back early by turning the body.*
- *Increase the length of the stroke for longer shots.*
- *Contact the ball out in front.*
- *Recover and get ready between shots.*

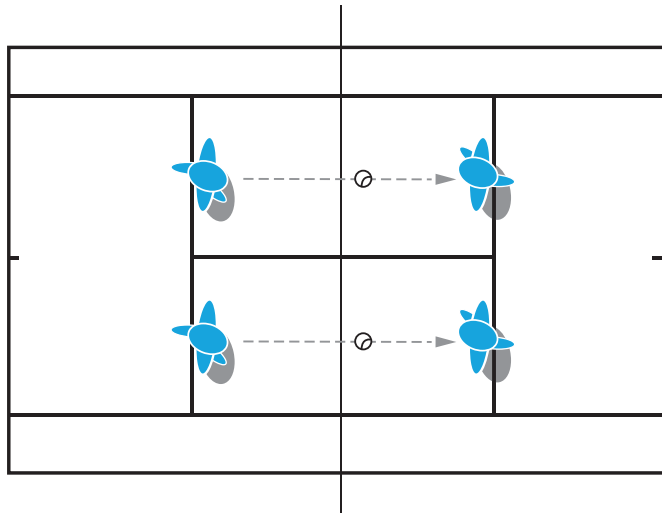

Main Theme One

L2

PLAYERS

- Hitter, Feeder, Collector - each player to hit 10 forehands crosscourt and swap.
- Then each player to hit 10 backhands and swap.
- Teacher to demonstrate a forehand and backhand crosscourt.

SAFETY POINTS

- Some players may need to be closer to the net.

QUALITY POINTS

- *Balanced ready position.*
- *Unit turn.*
- *Low to high swing.*
- *Change the angle of the racket face to point strings in the direction of the target area (crosscourt).*

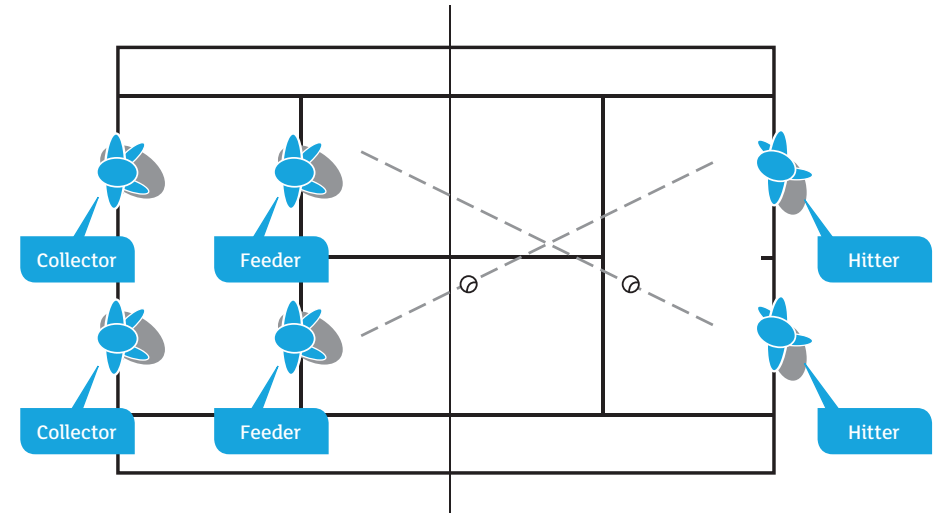

Main Theme Two

L2

PLAYERS

- Two players - working on one half of the court.
- Three players - working on half a court. Two at one end, rotate after each rally, player at the other end stays on.
- Four players - as per diagram.
- Five players - as per diagram with fifth player at the side of the court skipping. All players rotate one place to the left at the end of the rally.
- Six players - two groups of three. One player by themselves the other two at the other end, the two players rotate after each rally.
- Eight players - as per diagram with a waiting player behind each hitter, rotate after each rally.

SAFETY POINTS

- With more than two players use cones to mark out safe area at the back of the court for waiting players.
- If the ball goes into the wrong half, leave it.

ACTIVITIES

Stage 1: Co-operative Activity

- Player 1 feeds the ball in underarm to Player 2 and counts the length of the rally.

Stage 2: Competitive Activity

- Rally of four and play out the point.

QUALITY POINTS

- *Point strings, shoulders and hips in the direction they want the ball to go i.e. crosscourt.*
- *Control racket path in a straight line.*
- *Stabilize wrist position with a contact point in front.*
- *Long hitting zone to control direction.*
- *Play the ball deep by aiming higher over the net.*

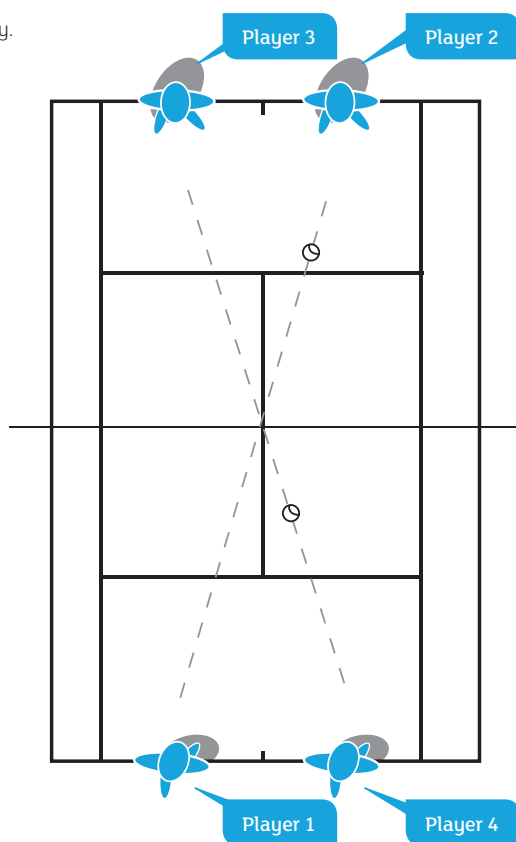

Main Theme Three

L2

PLAYERS

- Two players - working on one half of the court.
- Three players - working on half a court. Two at one end, rotate after each rally, player at the other end stays on.
- Four players - as per diagram.
- Five players - as per diagram with fifth player at the side of the court skipping. All players rotate one place to the left at the end of the rally.
- Six players - two groups of three. One player by themselves the other two at the other end, the two players rotate after each rally.
- Eight players - as per diagram with a waiting player behind each hitter, rotate after each rally.

SAFETY POINTS

- With more than two players use cones to mark out safe area at the back of the court for waiting players.
- If the ball goes into the wrong half, leave it.

ACTIVITIES

Stage 1: Co-operative Activity

- Players to rally and try to keep the ball past the service line.
- Players must hit only forehands/backhands and must recover to relevant area (just left or right of centre).

Stage 2: Competitive Activity

- Rally of four and play out the point.

QUALITY POINTS

- *Control racket path in a straight line.*
- *Stabilize wrist position with a contact point in front.*
- *Long hitting zone to control direction.*
- *Play the ball deep by aiming higher over the net.*
- *Point Strings, shoulders and hips in the direction they hit the ball to go i.e. crosscourt.*

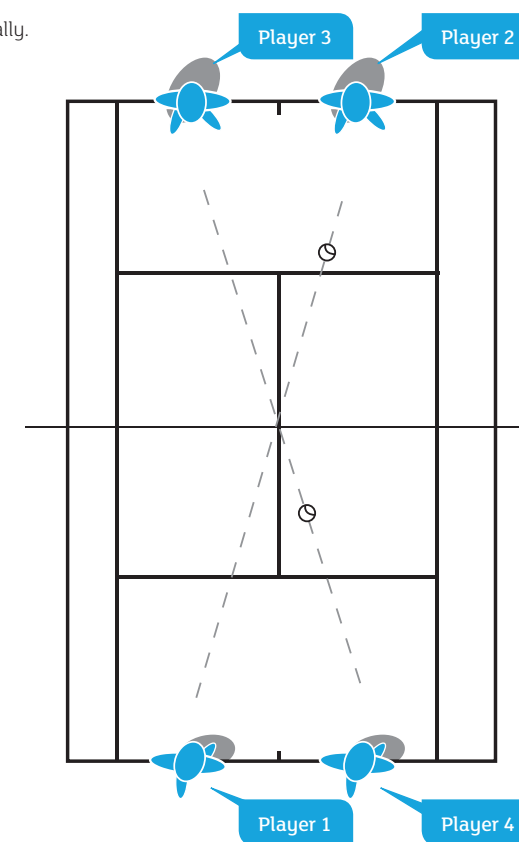

COMPETITION

Both Back

L2

HARD ACTIVITY

- Players must make their opponent step outside the doubles tramlines.
- One or both players must stay inside the baseline and take the ball early to take time away from their opponent.
- Players must rally keeping the ball past the service line.
- Differentiation - One player must hit past the service line, the other can hit anywhere in the court.

EASIER ACTIVITY

All practices can be made easier by using green, orange or red balls.

- Player 1 feeds the ball in from the baseline and rallies cross court with Player 2.
- Player 1 feeds ball in from baseline and the ball may bounce twice inside the court area.
- One player feeds and the other hits.
- Both players throw and catch.

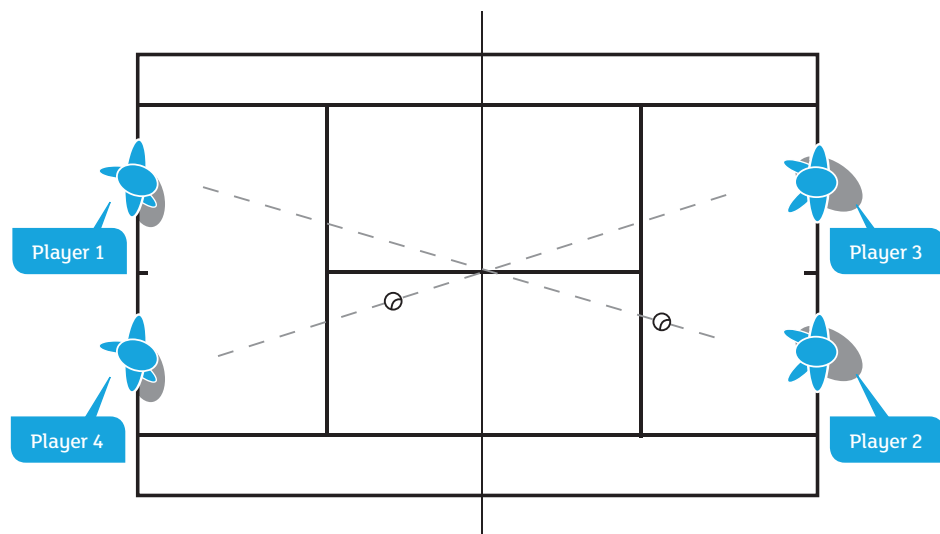

WARM-UP ACTIVITY

Widths

L3

- Pupils jog from tram to tram with arms circling, sidestepping, crossover steps etc.
- Pupil to split step at each end.
- Teacher to reinforce running technique and introduce split step.

QUALITY POINTS

- *Keep your balance by leaning forwards slightly when jogging backwards.*
- *Do a split step at each end.*

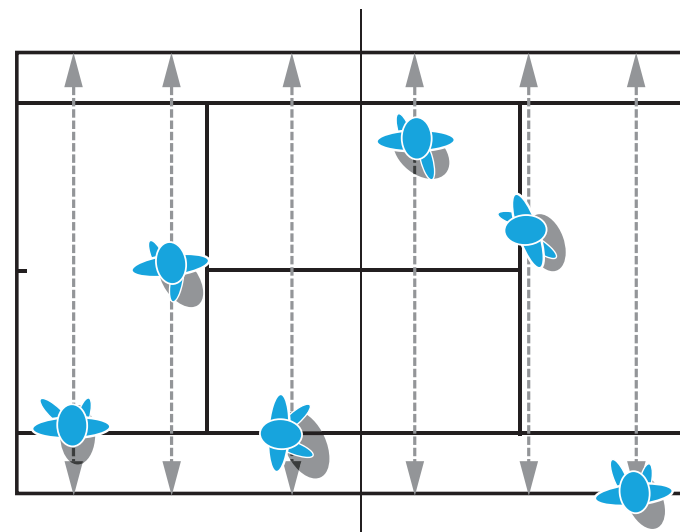

WARM-UP ACTIVITY

Target Throw

L3

- In pairs one player at each end of the court.
- Set up sideways with feet behind the line.
- Get a good ready to throw position.
- Line shoulders up with where the ball should go.
- Players throw the ball over arm to each other.
- Aim upwards and forwards.
- Finish in a balanced position.

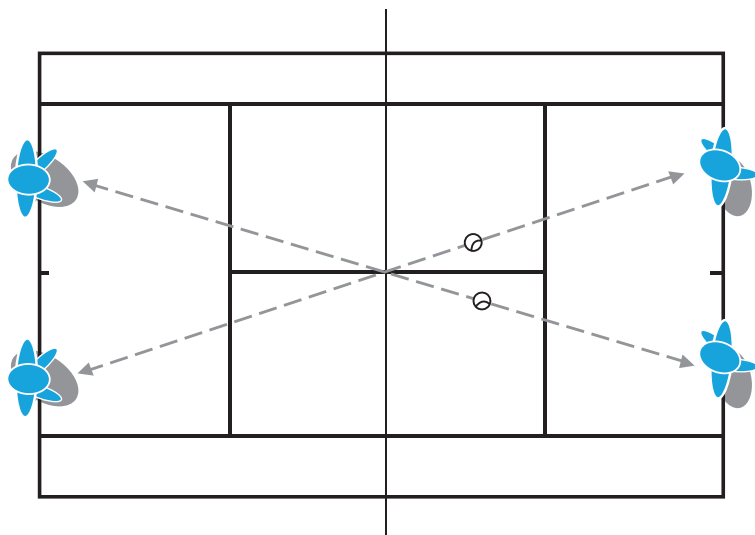

Main Theme One

L3

SERVE

- Players go through the progressions of the serve:
 1. Balanced starting position, racket in one hand and ball in another:
 2. For rhythm: hands go down together – separate up together.
 3. To practice ball toss: racket stops in pre throw position.
 4. Place ball in air and catch with non dominant arm.
 5. To hit: place ball in the air and hit overhead.
- Players hit five serves and swap.
- Teacher to demonstrate Serve and Return.

RETURN

- Players start in a balanced ready position and split step when the server hits the ball.
- Contact in front.
- Point strings in the direction they want the ball to go.
- Shorter swing on faster balls.

QUALITY POINTS

- Control racket path in a straight line.
- Stabilize wrist position with a contact point in front.
- Long hitting zone to control direction of passing shot.
- Changing path of the racket (more low to high) /angle of play lob.

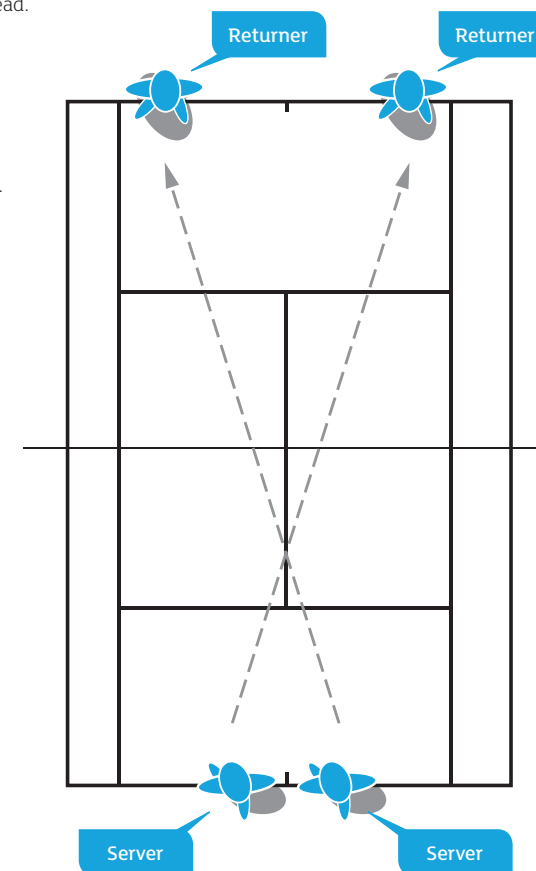

Main Theme Two

L3

SERVE

- Two players - as per diagram.
- Three players - two at one end, rotate after each rally, player at the other end stays on.
- Four players - two at each end rotating after each rally (remember to swap opponents!).
- Five players - three at one end, two at the other. Rotate after each rally.
- Six players - three at each end. Rotate one end after each rally and the other end stay on for two rallies.

QUALITY POINTS

- *Control racket path in a straight line.*
- *Stabilize wrist position with a contact point in front.*
- *Long hitting zone to control direction of passing shot.*
- *Changing path of the racket (more low to high) /angle of play lob.*

SAFETY POINTS

- With more than two players use cones to mark out safe area at the back of the court for waiting players.

ACTIVITIES

Stage 1: Co-operative Activity

- Player 1 serves to Player 2 who returns the ball crosscourt.
- Five turns each and swap.

Stage 2: Competitive Activity

- Player 1 serves to Player 2 to play out the point.

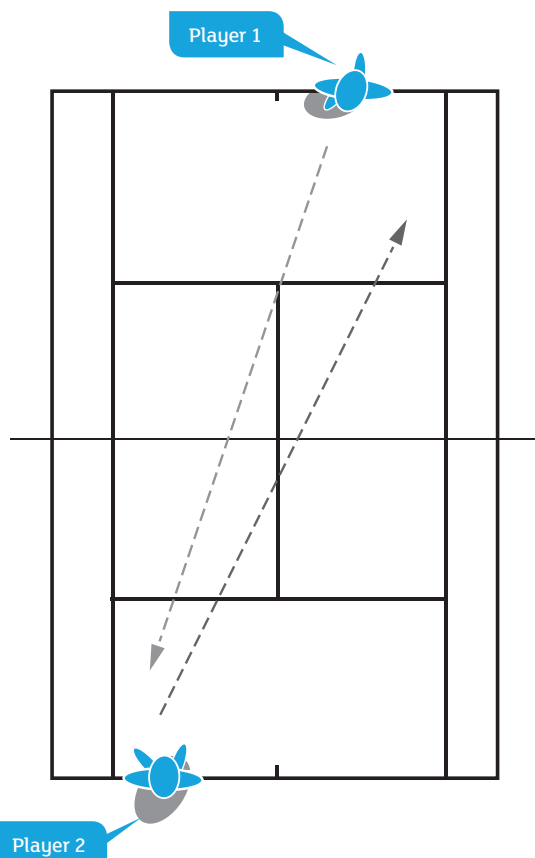

Main Theme Three

L3

SERVE

- Two players - as per diagram.
- Three players - two at one end, rotate after each rally, player at the other end stays on.
- Four players - two at each end rotating after each rally (remember to swap opponents!).
- Five players - three at one end, two at the other. Rotate after each rally.
- Six players - three at each end. Rotate one end after each rally and the other end stay on for two rallies.

QUALITY POINTS

- *Control racket path in a straight line.*
- *Stabilize wrist position with a contact point in front.*
- *Long hitting zone to control direction.*
- *Play the ball deep by aiming higher over the net.*
- *Point Strings, shoulders and hips in the direction they hit the ball to go i.e. crosscourt.*

SAFETY POINTS

- With more than two players use cones to mark out safe area at the back of the court for waiting players.

ACTIVITIES

Stage 1: Co-operative Activity

- Player 1 serves and prepares for the next shot.
- Player 2 returns the ball crosscourt to Player 1 who hits the 3rd shot back to Player 2 who catches the ball.
- Player 2 now serves.

Stage 2: Competitive Activity

- Player 1 serves to Player 2 to play out the point.

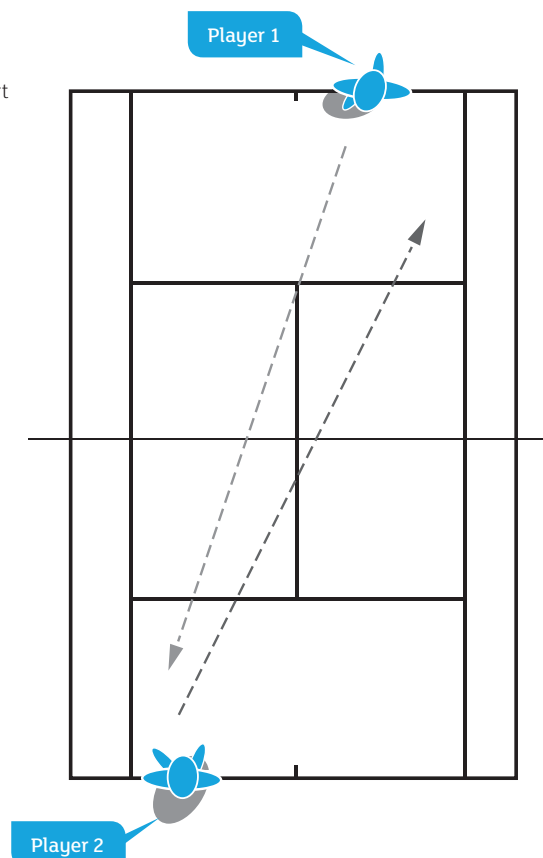

COMPETITION

Serve and Return

L3

HARD ACTIVITY

Serve

- Split service box into three areas (see picture).
- Player must hit serves either to A, B or C.
- Server must move opponent outside tramlines (see picture).
- Server must serve to either the opponent's forehand or backhand.

Return

- Returner must return to designated target area (see picture).
- Returner must return to server's forehand or backhand.

EASIER ACTIVITY

All practices can be made easier by using green, orange or red balls.

Serve

- Server may serve anywhere.
- Throw the ball in over arm.
- Server may serve under arm.

Return

- Return anywhere.
- Returner has to stop the ball with their racket.

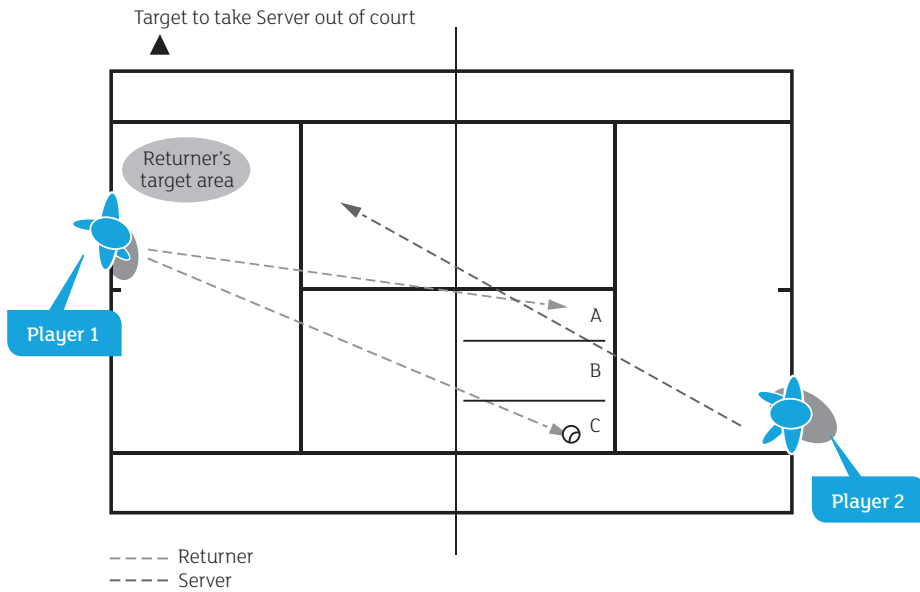

WARM-UP ACTIVITY

10, 10, 10

L4

- In pairs players have a tap up rally of 10.
- They find another partner to have a rally of 10.
- After successful completion of rally of 10 with a third partner call out "10, 10, 10".

QUALITY POINTS

- Sideways on.
- Short swings to tap up ball.
- Ball must go up.

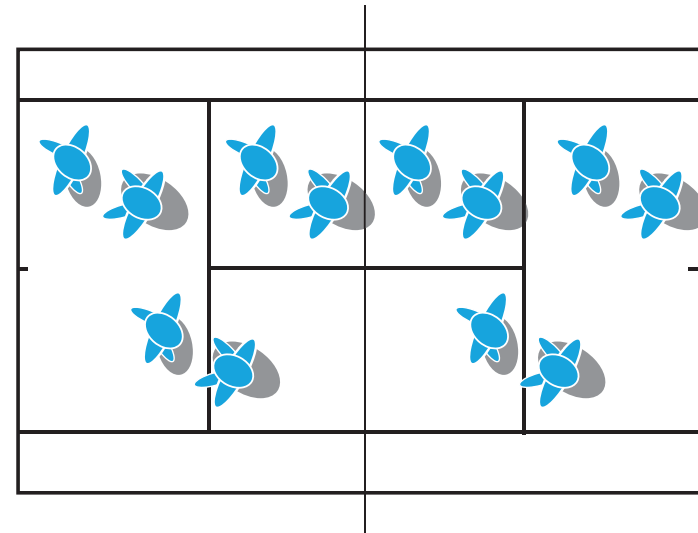

WARM-UP ACTIVITY Volleyball

L4

- In teams with all players at the net.
- Alternate feeds and every ball must be volleyed up.
- Ball must be passed to a member of the same team before going over the net.
- The team that allows the ball to bounce loses the point.

QUALITY POINTS

- *Players to call "mine" for their shot.*
- *Players must not swing their rackets.*

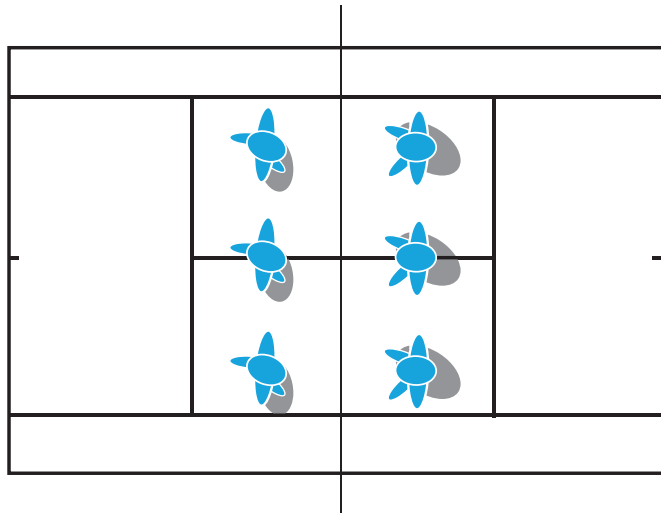

Main Theme One

L4

PLAYERS

- Hitter, Feeder, Collector - Each player to hit five forehand and five backhand volleys back to feeder and swap.
- Balanced ready position, contact point out in front, blocking action on volley.
- Teacher to demonstrate the volley.

QUALITY POINTS

- *Control racket path in a straight line.*
- *Stabilize wrist position with a contact point in front.*

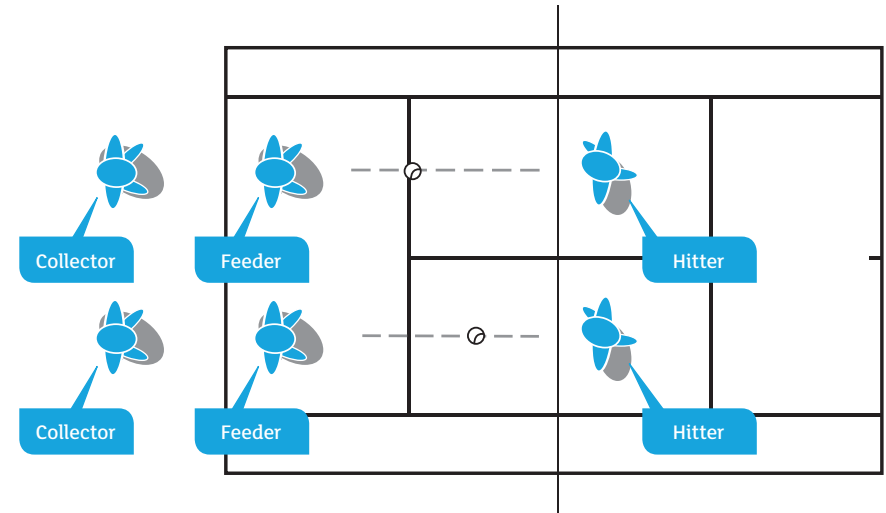

Main Theme Two

L4

PLAYERS (1/2 COURT)

- Two players - as per diagram.
- Three players - two at one end, rotate after each rally, player at the other end stays on.
- Four players - two at each end rotating after each rally (remember to swap opponents!).
- Five players - three at one end, two at the other. Rotate after each rally.
- Six players - three at each end. Rotate one end after each rally and the other end stay on for two rallies.

QUALITY POINTS

- *Control racket path in a straight line.*
- *Stabilize wrist position with a contact point in front.*
- *Player to split step when the opponent hits the ball.*

SAFETY POINTS

- With more than two players use cones to mark out safe area at the back of the court for waiting players.

ACTIVITIES

Stage 1: Co-operative Activity

- In Pairs, one player on baseline and one on service line.
- The player on the service line feeds the ball in to the baseline player who returns the ball for feeder to volley.
- Aim to hit both a forehand and a backhand volley.

Stage 2: Competitive Activity

- Player 1 feeds short ball to Player 2.
- Player 2 hits approach and plays out the point.
- The point may be won either on the approach or subsequent volleys.

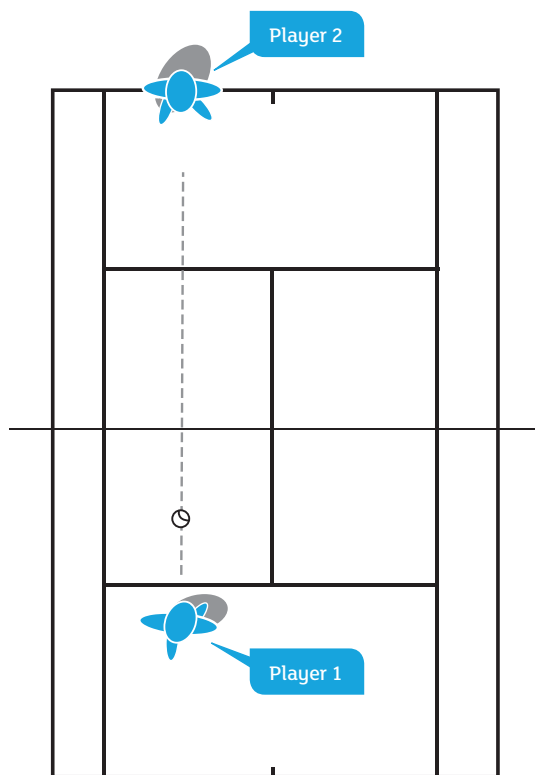

Main Theme Three

L4

PLAYERS (1/2 COURT)

- Two players - as per diagram.
- Three players - two at one end, rotate after each rally, player at the other end stays on.
- Four players - two at each end rotating after each rally (remember to swap opponents!).
- Five players - three at one end, two at the other. Rotate after each rally.
- Six players - three at each end. Rotate one end after each rally and the other end stay on for two rallies.

QUALITY POINTS

- *Control racket path in a straight line.*
- *Stabilize wrist position with a contact point in front.*
- *Long hitting zone to control direction.*
- *Player to split step when the opponent hits the ball.*

SAFETY POINTS

- With more than two players use cones to mark out safe area at the back of the court for waiting players.

ACTIVITIES

Stage 1: Co-operative Activity

- Player 1 feeds the ball short to Player 2 who hits an approach shot and moves in to volley.
- Player 1 to return ball or feed another for Player 2 to hit a forehand or backhand volley.

Stage 2: Competitive Activity

- Player 1 feeds short ball to Player 2.
- Player 2 hits approach and plays out the point.
- The point may be won either on the approach or subsequent volleys.

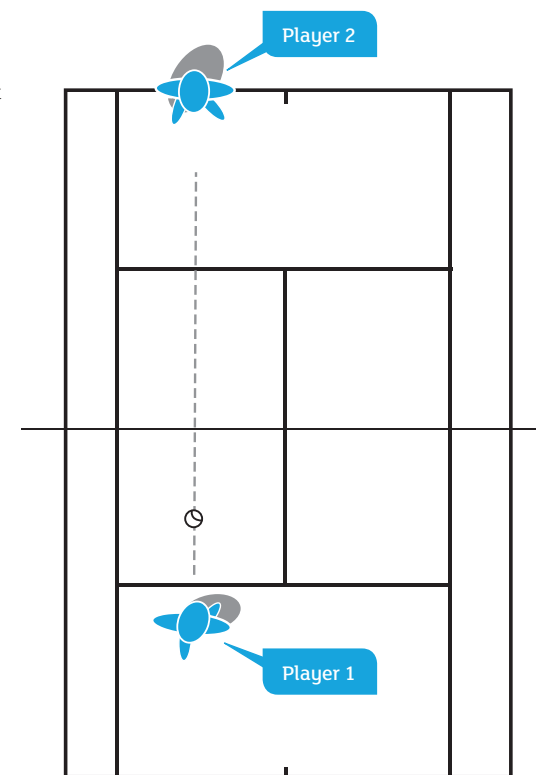

COMPETITION

Approaching the Net

L4

HARD ACTIVITY

- Players rally from the baseline and choose which ball to approach on.
- The approach shot must land in the back third of the court.
- Players must use their strength to play to the opponent's weakness i.e. forehand approach down the line to backhand.
- Differentiation - One player must hit the approach past the service line, the other player may hit the approach anywhere in the court.

EASIER ACTIVITY

All practices can be made easier by using green, orange or red balls.

- Player 1 feeds ball in from baseline to Player 2 who is at the net and volleys it back.
- Player 2 starts at the net. Feeds ball in to be hit by Player 1 and then volleys.
- Player 2 shadows an approach shot and moves in. Player 1 hand feeds a volley.

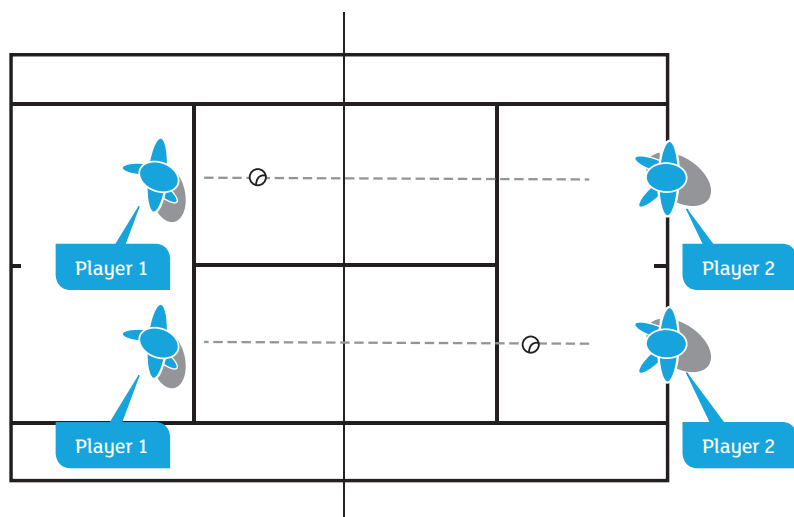

WARM-UP ACTIVITY

React 'n Go

L5

- In pairs players face the same direction with Player 1 on doubles tramline behind Player 2 on singles tramline.
- Player 1 throws ball over partner's head or rolls between legs.
- Player 2 sprints to catch the ball before it reaches the far tramlines.
- Players swap.
- Can use 1 then 2 balls.

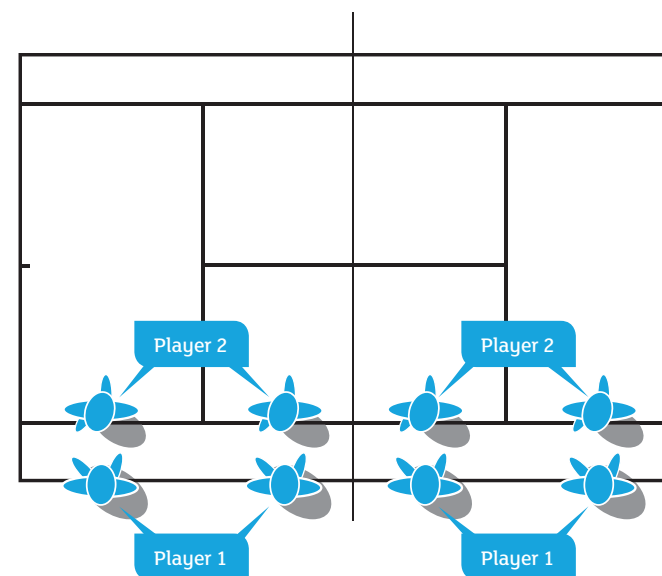

WARM-UP ACTIVITY

Step Back Rallies

L5

- Players start close to the net hitting forehands and backhands.
- With each successful hit they take a step backwards until they reach the baseline.
- Point strings in the direction the ball is intended to go.
- Turn sideways for forehands and backhands.

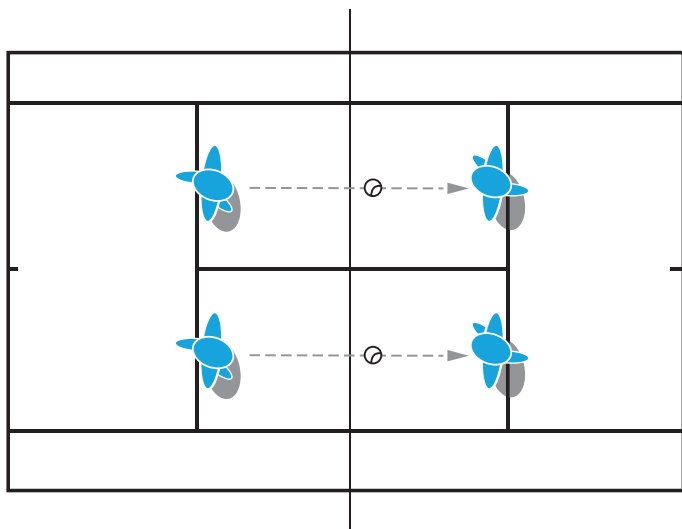

Main Theme One

L5

PLAYERS (1/2 COURT)

- Hitter, Feeder, Catcher – Player 1 (feeder) in service box feeds ball to Player 2 (hitter) on the baseline.
- Player 2 hits a forehand lob over Player 1 to Player 3 (catcher) who stands just inside the baseline.
- X goes each and swap.
- Repeat with backhand lob.
- Controlled low to high swing, open racket face for height over the net.
- Feeders must not be able to reach the ball.
- Teacher to demonstrate the lob.

QUALITY POINTS

- *Control racket path in a straight line.*
- *Stabilize wrist position with a contact point in front.*
- *Long hitting zone to control direction of passing shot.*
- *Changing path of the racket (more low to high) /angle to play lob.*

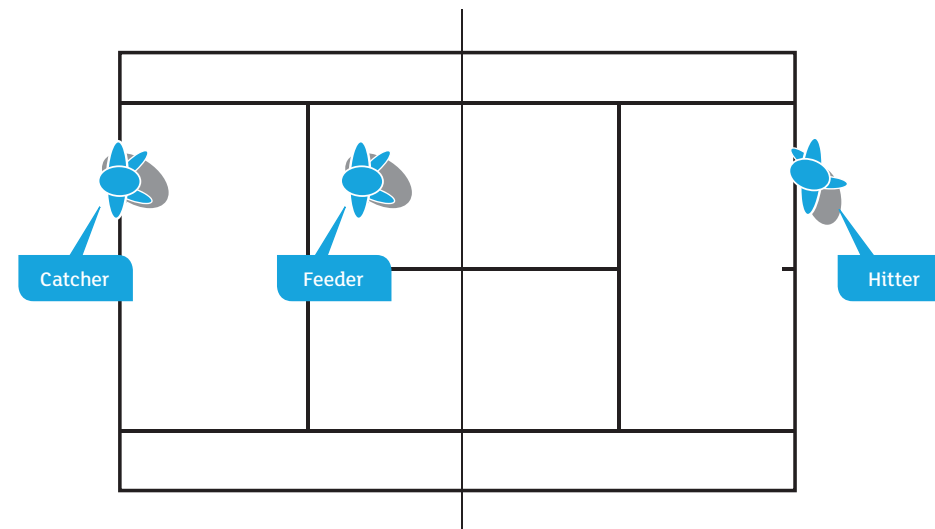

Main Theme Two

L5

PLAYERS (1/2 COURT)

- Two players - as per diagram.
- Three players - two at one end, rotate after each rally, player at the other end stays on.
- Four players - two at each end rotating after each rally (remember to swap opponents!).
- Five players - three at one end, two at the other. Rotate after each rally.
- Six players - three at each end. Rotate one end after each rally and the other end stay on for two rallies.

QUALITY POINTS

- *Control racket path in a straight line.*
- *Stabilize wrist position with a contact point in front.*
- *Long hitting zone to control direction of passing shot.*
- *Changing path of the racket (more low to high) /angle to play lob.*

SAFETY POINTS

- With more than two players use cones to mark out safe area at the back of the court for waiting players.

ACTIVITIES

Stage 1: Co-operative Activity

- Player 1 feeds the ball in deep from the service box to Player 2 who hits a lob (see picture).
- Player 1 can try to return the ball.
- Five lobs each and swap.

Stage 2: Competitive Activity

- Player 1 feeds and approaches.
- Players play out the point.
- Play five points each and swap.

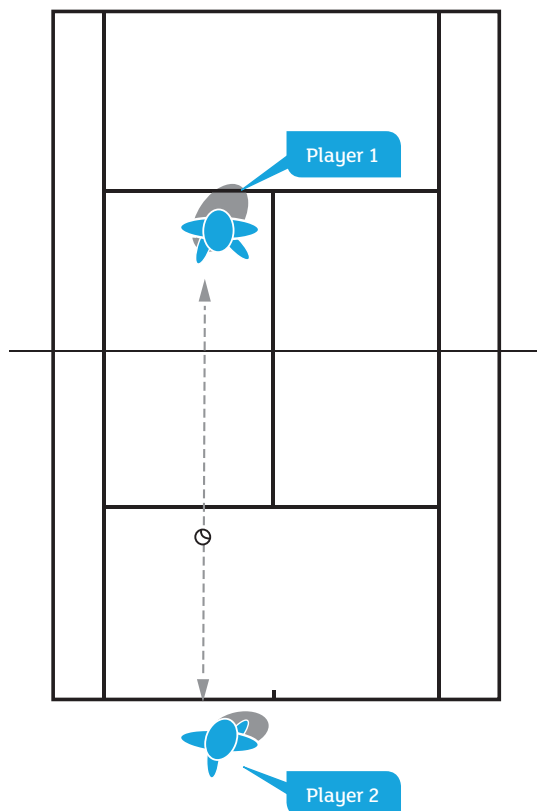

Main Theme Three

L5

PLAYERS (1/2 COURT)

- Two players - as per diagram.
- Three players - two at one end, rotate after each rally, player at the other end stays on.
- Four players - two at each end rotating after each rally (remember to swap opponents!).
- Five players - three at one end, two at the other. Rotate after each rally.
- Six players - three at each end. Rotate one end after each rally and the other end stay on for two rallies.

QUALITY POINTS

- *Control racket path in a straight line.*
- *Stabilize wrist position with a contact point in front.*
- *Long hitting zone to control direction of passing shot.*
- *Changing path of the racket (more low to high) /angle to play lob.*

SAFETY POINTS

- With more than two players use cones to mark out safe area at the back of the court for waiting players.

ACTIVITIES

Stage 1: Co-operative Activity

- Starting on the service line Player 1 feeds the ball in to Player 2 and closes in.
- Player 2 hits a lob or passing shot.
- Players feed alternately.

Stage 2: Competitive Activity

- Players feed and approach alternately.
- Players play out the point.
- Extra points for a winning lob.

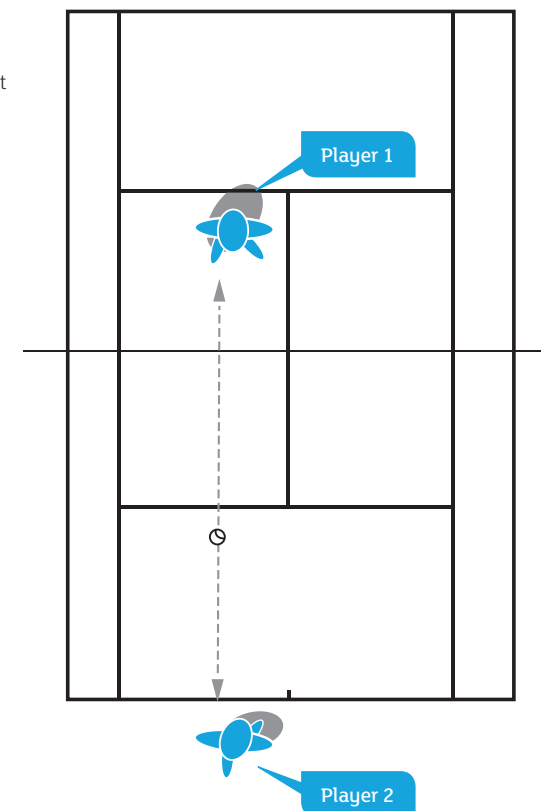

COMPETITION

Approaching the Net

L5

HARD ACTIVITY

- Players rally and choose when to approach so that the opponent must hit an attacking lob or passing shot.
- Player 2 must hit a lob or a passing shot to a target area.
- Differentiation - lobs only/passing shots only.
- Forehands/backhands only.

EASIER ACTIVITY

All practices can be made easier by using green, orange or red balls.

- Player 1 hand feeds ball from the net to Player 2 who can hit either a lob or a passing shot.
- Player 2 self feeds a lob or passing shot.

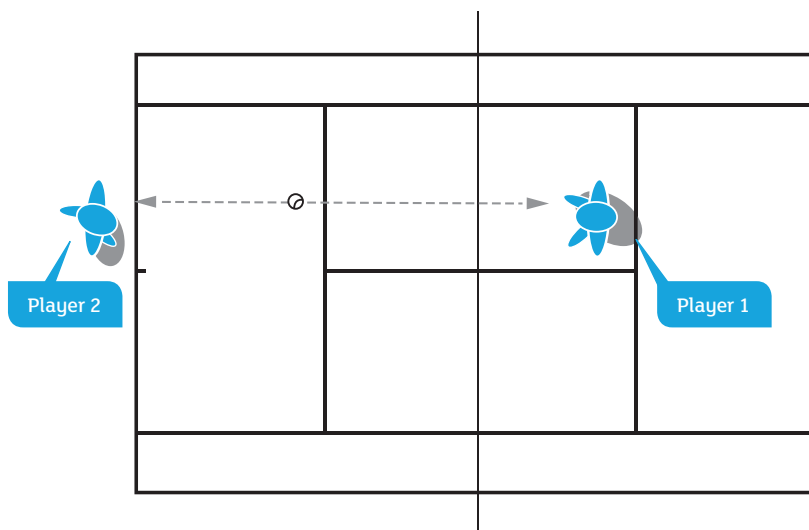

WARM-UP ACTIVITY

Rally Races

L6

- Players in service boxes have a rally race for 10 forehand to forehand.
- Backhand to backhand.
- One volleys, one hits groundstrokes for 10 and swap.
- Volley to volley for 10.

QUALITY POINTS

- *Keep your head up to watch your partner as well as the ball.*
- *Have a balanced base and light footwork.*

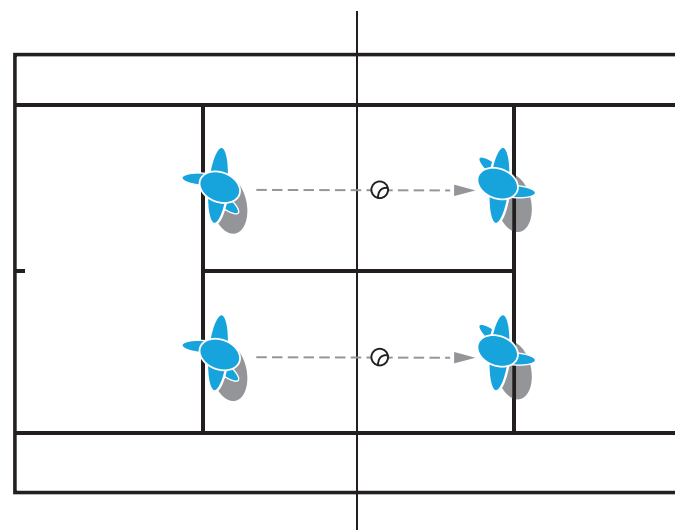

WARM-UP ACTIVITY

Dingles

L6

- Four players rally crosscourt, two on forehand and two on backhand side.
- When one pair makes an error they shout “dingles” and the point is then played as doubles.

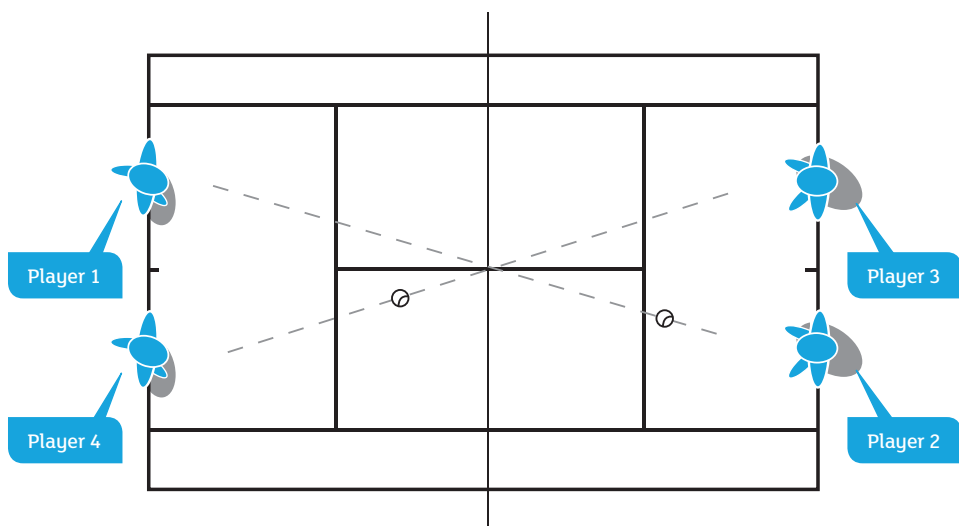

Main Theme One

L6

PLAYERS

- Four players as per diagram.
- Five players, one player at the net post and rotate after x points.
- Six players, as per diagram with two players waiting at the back of the court behind a coned area. Rotate after x points.
- Seven+ players as per diagram with players waiting at both ends of the court. Rotate after x points.
- Teacher to demonstrate drill.

SAFETY POINTS

- With more than four players use cones to mark out safe area.
- The back of the court for waiting players.
- Use of cones to space.

ACTIVITIES

Stage 1: Co-operative Activity

- Player 1 feeds the ball, Player 3 returns ball and approaches.
- All players take turns to feed and approach.

Stage 2: Competitive Activity

- Player 1 feeds the ball to Player 3.
- Players rally crosscourt.
- Players approach on a short ball.
- Play out point.

QUALITY POINTS

- Cover all angles.
- Blocking on the volley, throwing action on the smash.
- Movement diagonally forward for the volley, movement back for the smash.
- Concentration, decision making.
- Player 1 or Player 2 call for volley or smash. Use MINE not YOURS.
- Work to stay level and cover the middle.
- Decide who chases lobs – player who crosses the service line first chases the lob.

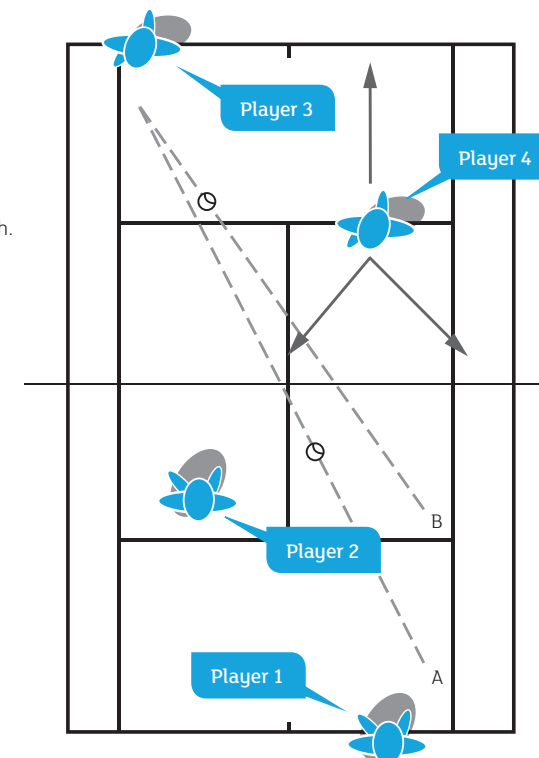

Main Theme Two

L6

PLAYERS

- Four players as per diagram.
- Five players, one player at the net post and rotate after x points.
- Six players, as per diagram with two players waiting at the back of the court behind a coned area. Rotate after x points.
- Seven+ players as per diagram with players waiting at both ends of the court. Rotate after x points.

SAFETY POINTS

- With more than four players use cones to mark out safe area.
- The back of the court for waiting players.
- Use of cones to space.

ACTIVITIES

Stage 1: Co-operative Activity

- Player 1 serves to A, B or C. Player 3 returns cross court, Player 2 looks to intercept.

Stage 2: Competitive Activity

- Player 1 serves to A, B or C. Player 3 returns cross court, Player 2 looks to intercept and play out the point.

QUALITY POINTS

For the Server:

- *1st serve to serve to A, B or C. Second serve ball in play.*
- *Throwing action for the serve, angle of racket face, use of spin for direction.*
- *Recovery to cover your half of the court (stay back or serve and volley).*
- *Concentration, decision making.*

For the Server's Partner:

- *To look to intercept cross court returns.*
- *Move diagonally forward and block the volley.*
- *Good ready position ready to move diagonally forward.*
- *Concentration, decision making.*

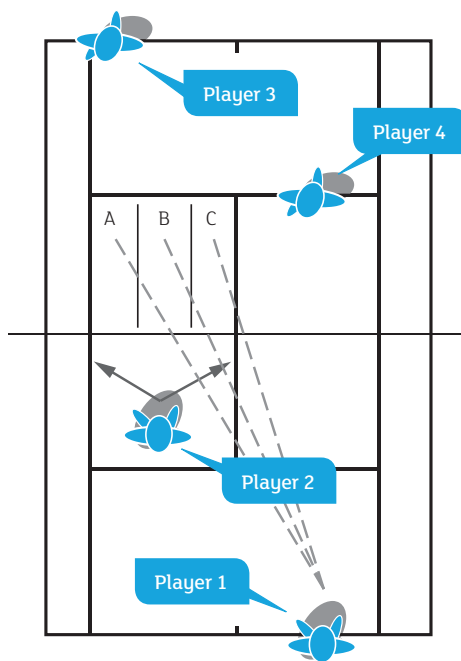

Main Theme Three

L6

PLAYERS

- Four players as per diagram.
- Five players, one player at the net post and rotate after x points.
- Six players, as per diagram with two players waiting at the back of the court behind a coned area. Rotate after x points.
- Seven+ players as per diagram with players waiting at both ends of the court. Rotate after x points.

SAFETY POINTS

- With more than four players use cones to mark out safe area.
- The back of the court for waiting players.
- Use of cones to space.

ACTIVITIES

Stage 1: Co-operative Activity

- Player 3 returns to A off a first serve.
- Player 3 returns to A, B, or C off a second serve.

Stage 2: Competitive Activity

- Player 3 returns to A, B or C and play out the point.

QUALITY POINTS

For the Server:

- *Neutralise 1st serve, attack 2nd serve.*
- *Shorter action on 1st serve, longer swing to attack 2nd serve.*
- *Movement around the ball and recovery in your half of the court.*
- *Concentration, decision making.*

The Returner:

- *Split step when serve is hit.*
- *Block first serve.*
- *Point strings in the direction that you want the ball to go.*
- *Attack second serve and look to approach.*
- *Shorten swing on a faster serve.*

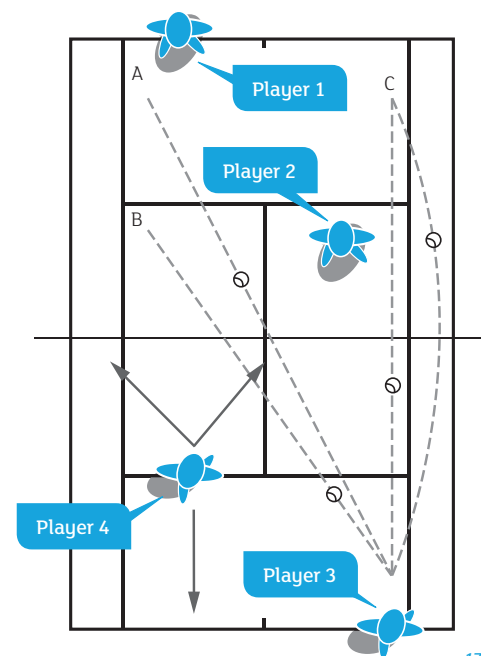

COMPETITION Round Robin

L6

- Place pairs of pupils into groups.
- Pairs play against other pairs in their groups.
- Length of matches / number of pairs in each group depends on time and facilities available.
- See Schools Competition Guide for templates and formats to assist in running Round Robin Competitions.

Group	A	B	C	D	Wins	Points for	Points played	Positions
A								
B								
C								
D								

Mix & Match

ACTIVITY CARDS



ABCs - COORDINATION

2 Touch Tennis

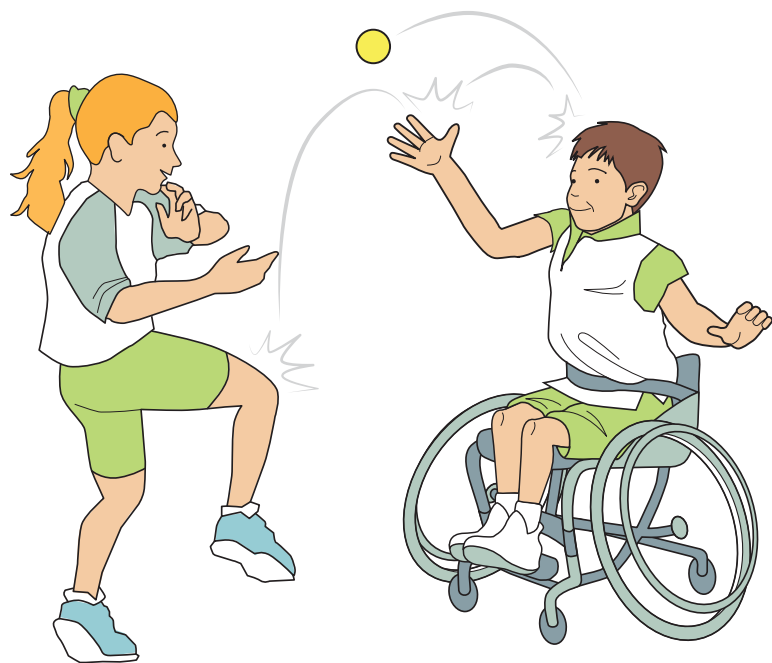

Standing 1m apart, hit the ball to each other. Each player has to do 2 touches, one with a hand and one with another part of the body.

EASIER

- Do both hits with hand or hands.

HARDER

- Don't use hands for either of the hits.
- Use 2 balls.

TIPS

Keep knees bent with a wide base to help you stay balanced and ready to move.

ORGANISATION AND SAFETY

- Spacing between players.
- Loose balls.

KEY ELEMENTS COVERED

- Coordination of whole body.
- Balls sense.
- Movement.
- Balance.
- Ready position.
- Focus on the ball.
- Recovery.

LEARNING OUTCOMES

- Identify areas of fitness most needed in the game.
- Develop kinaesthetic awareness.

SCORING

- 6 touches = 1 point.
- 12 touches = 2 points.
- 20 touches = 5 points.

EVALUATION

- How effective were you in this skill?
- What do you feel you did well?
- What did you learn?
- What would you like to develop further?

ABCs - COORDINATION

Quick Hands

EQUIPMENT

1 player, 1 large ball (e.g. football)

Stand with feet wide apart and the ball on the floor between your feet.

- Bend your knees and put both hands on the ball with one hand in front of your legs and the other hand behind your legs. Pick the ball up then let it drop, change your hands around and catch it after the bounce.

EASIER

- *Keep the ball on the ground and move hands to touch it.*

HARDER

- *Catch it before the bounce.*
- *Use a tennis ball.*

TIPS

- Keep knees bent and your back straight.

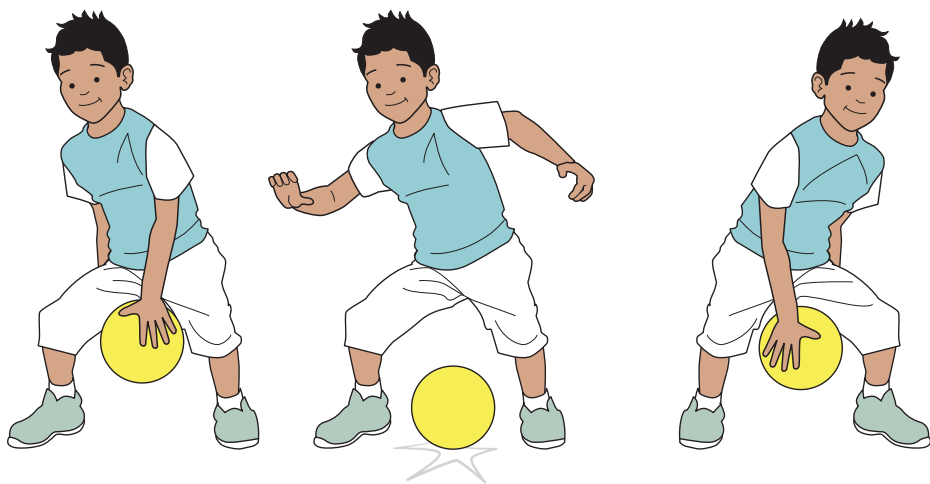

ORGANISATION AND SAFETY

- Spacing between players.
- Loose balls.
- Standing on the balls.

KEY ELEMENTS COVERED

- Coordination.
- Reaction to the ball.
- Balance.
- Ready position.
- Stance.

LEARNING OUTCOMES

- Identify areas of fitness most needed in the game.
- Develop kinaesthetic awareness.

SCORING

- How many can you do in 30 seconds?

EVALUATION

- How effective were you in this skill?
- What do you feel you did well?
- What did you learn?
- What would you like to develop further?

ABCs - SPEED & AGILITY

Every which way

EQUIPMENT

2 Players, 2 balls

Player 1 stands with 2 balls behind Player 2, who stands facing across the court ready to run:

- Player 1 rolls the 2 balls past Player 2 (could be through the legs).
- Player 2 runs after the balls preparing to pick them up.
- Player 1 calls out 'Right, Left' or 'Left, Right' indicating the order in which to pick the balls up.

EASIER

- Roll 1 ball.

HARDER

- Roll 3 balls and shout in any order 'Right, Middle, Left'.
- Player 1 picks up balls in opposite order to that given by Player 2.

TIPS

- Roll the ball at a challenging pace – not too quick, not too slow.
- Call out immediately after the roll action.

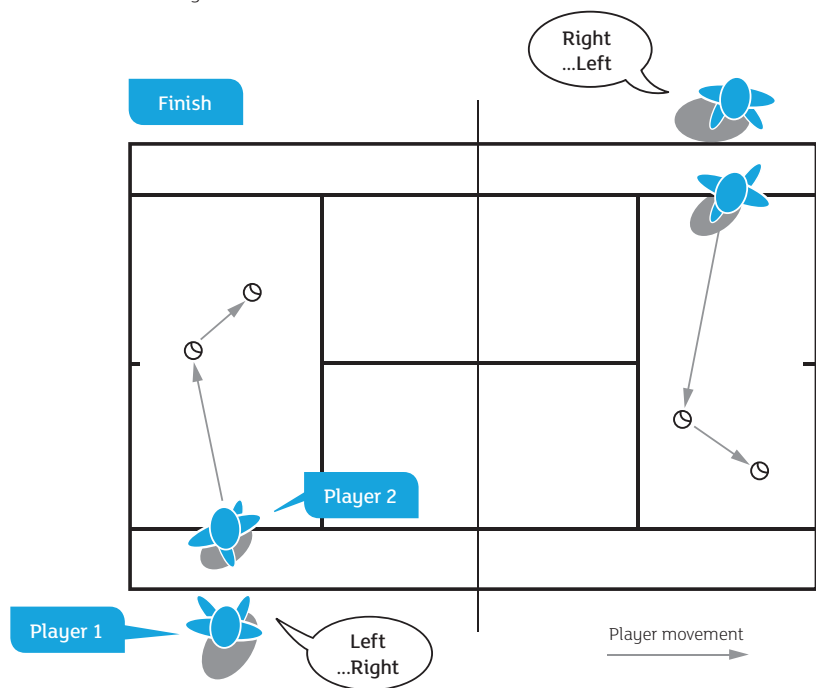

ORGANISATION AND SAFETY

- Spacing between players.
- Loose balls.

KEY ELEMENTS COVERED

- Speed and agility.
- Speed of reaction.
- Peripheral vision.
- Ready position.
- Anticipation.
- Balance.

LEARNING OUTCOMES

- Identify areas of fitness most needed in the game.
- Develop kinaesthetic awareness.

SCORING

- 1 point per ball picked up.

EVALUATION

- How effective were you in this skill?
- What do you feel you did well?
- What did you learn?

ABCs - STRENGTH

Press up tennis

EQUIPMENT

2 players, 1 ball, 1 square made using throw down lines or cones (2-3 shoes length for each side)

Both players get onto hands and feet in a press up position, facing each other.

- Throw and catch the ball to each other letting it bounce in the square.

EASIER

- Do the press up on knees.

HARDER

- Play points. The square is in.

TIPS

- Nothing to mark out a square? Play over a line on the court.
- Keep a good press up position – don't let your back drop down.

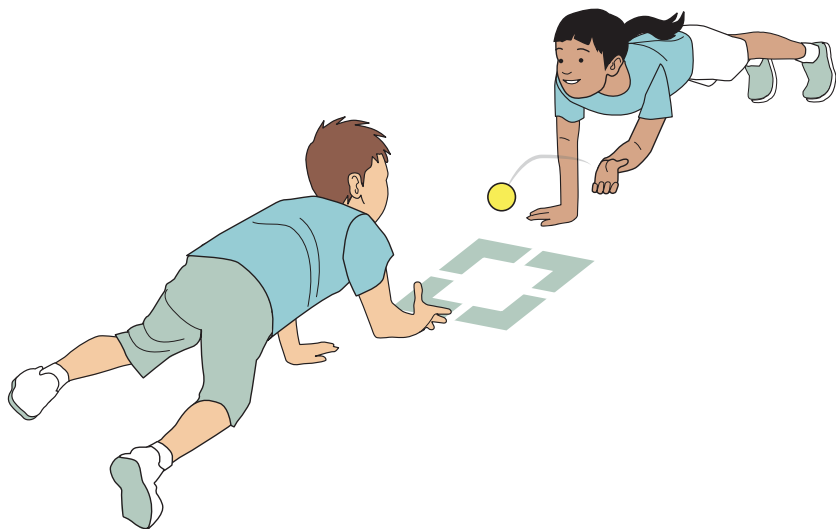

ORGANISATION AND SAFETY

- Spacing between players.
- Loose balls.

KEY ELEMENTS COVERED

- Strength.
- Coordination.
- Feeding accurately with a partner.
- Weight transfer.

LEARNING OUTCOMES

- Identify areas of fitness most needed in the game.
- Develop kinaesthetic awareness.

SCORING

- How long a rally can you and your partner get?
- Play points against each other.

EVALUATION

- How effective were you in this skill?
- What do you feel you did well?
- What did you learn?
- What would you like to develop further?

TRICKS

Air & Groundies

EQUIPMENT

2 players, 2 rackets, 2 balls

Players start facing each other, 4m apart

- Player 1 kicks one ball along the floor to Player 2. At the same time Player 2 hits the other ball to Player 1 using a racket. The 'hit' ball must bounce once before being hit back. Keep both balls moving.
- Count: 1 each time the air ball is hit. Stop counting when either of the balls is missed or when the air ball bounces twice.

EASIER

- *For the hit, push the ball along the floor.*

HARDER

- *Kick with alternate feet.*
- *Hit with alternate hands.*

COMPETITIVE

- Count 1 each time the air ball is hit. Stop counting when either of the balls is missed or when the air ball bounces twice.

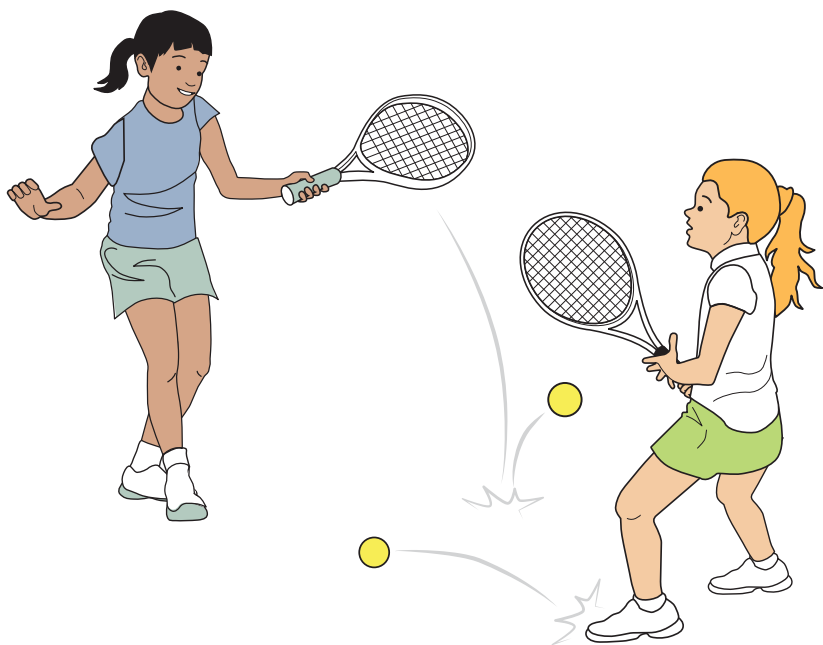

TIPS

- Synchronise with your partner so that you each contact a ball at the same time.

ORGANISATION AND SAFETY

- Spacing between pairs.
- Loose balls.

KEY ELEMENTS COVERED

- Movement around the court.
- Balls sense.
- Forehand.
- Backhand.
- Hit to partner.
- Co-operation with partner to achieve mutual success.
- Keep the ball in play.

LEARNING OUTCOMES

- Hit the ball with reasonable consistency and accuracy in cooperative rallies.

SCORING

- Up to 5 = 1 pt.
- Up to 10 = 2 pts.
- Up to 15 = 3 pts, etc.
- Devise your own scoring with a group or your partner.

EVALUATION

- How effective were you in this skill?
- What do you feel you did well?
- What did you learn?
- What would you like to develop further?

TRICKS

Edgie Uppies

EQUIPMENT

1 player, 1 racket, 1 ball

- Hit the ball upwards using only the edge of your racket.
- Count: 1 for every edgie. If you miss, start counting again from 1.

EASIER

- Hit alternatively with strings and edge.
- Hold racket further up the handle.

HARDER

- Hold racket further down the handle.
- Alternate between an edgie and heading the ball.

COMPETITIVE

- Count 1 for every edgie. If you miss, start counting again from 1.

TIPS

- Use a chopper grip.
- Aim not to move around too much.

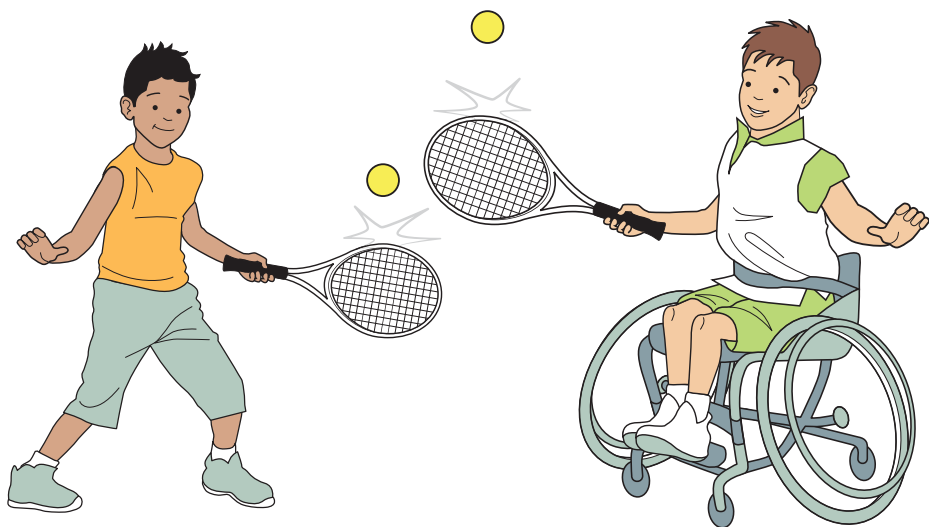

ORGANISATION AND SAFETY

- Spacing between players.
- Loose balls.
- Miss hits.

KEY ELEMENTS COVERED

- Hand eye coordination.
- Balls sense.
- Ball skills.
- Balance.
- Racket control.
- Grips.

LEARNING OUTCOMES

- Develop kinaesthetic awareness.

SCORING

- Up to 2 = 1 pt.
- Up to 3 = 2 pts.
- Up to 4 = 3 pts, etc.
- Who can get to 5?

EVALUATION

- How effective were you in this skill?
- What do you feel you did well?
- What did you learn?
- What would you like to develop further?

TRICKS

Double Down

EQUIPMENT

1 player, 2 balls

- Using both hands, continually bounce 2 tennis balls down to the floor. Aim to have both balls hitting the ground at the same time.
- Count: As the balls hit the floor count 1, 2, 3 etc. Stop counting when you lose control of either ball.

EASIER

- Bounce down 1 ball with alternate hands.

HARDER

- Use different size balls.
- Use one racket and one hand.
- Use 2 rackets.

TIPS

- Start by bouncing one ball, then add the 2nd ball once in a rhythm.

ORGANISATION AND SAFETY

- Spacing between players.
- Loose balls.

KEY ELEMENTS COVERED

- Hand eye coordination.
- Balls sense.
- Balance.
- Weight transfer.
- Movement.

LEARNING OUTCOMES

- Developing peripheral vision.
- Develop kinaesthetic awareness.

SCORING

- Time based, how many in 30 seconds.

EVALUATION

- How effective were you in this skill?
- What do you feel you did well?
- What did you learn?
- What would you like to develop further?

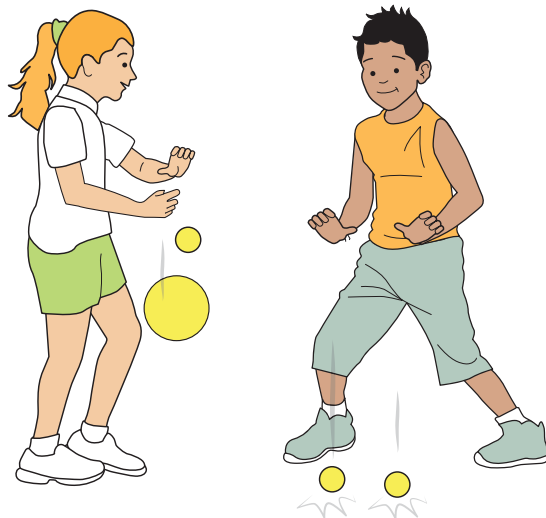

TRICKS

Colossal Catch

EQUIPMENT

1 player, 1 racket, 1 ball

Start with 1 ball resting on the racket face.

- Flick the ball high into the air in one movement.
- Then toss the racket 360° and catch the ball back down on the strings.
- Count: 1 for each ball you catch.

EASIER

- Just rotate the racket without using a ball to catch.

HARDER

- Do the same with 2 balls at once.

TIPS

- Flick the balls high but straight to give time to toss the racket.

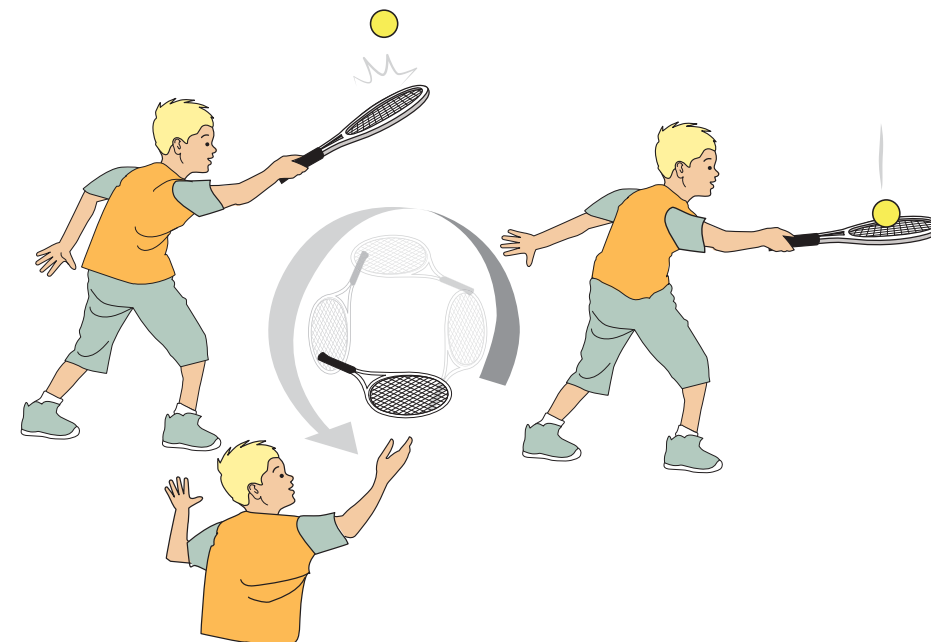

DRILLS

Both Back 1

GAME SITUATION

- Both back.

STRATEGY

- Consistency, getting the ball over and in, mainly focusing on moving opponent by controlling direction.

ORGANISATION

Players

- 2 players – as per diagram, using a yellow tennis ball.
- 3 players – 2 at one end, rotate after each rally, player at the other end stays on.
- 4 players – 2 at each end rotating after each rally (remember to swap opponents).
- 5 players – 3 at one end, 2 at the other. Rotate after each rally.
- 6 players – 3 at each end. Rotate one end after each rally and the other end stay on for 2 rallies.

Safety points

- With more than 2 players use cones to mark out safe area at the back of the court for waiting players.

KEY POINTS

- Set up: ready, read, react.
- Alert ready position.
- Judge ball and position back from the bounce.

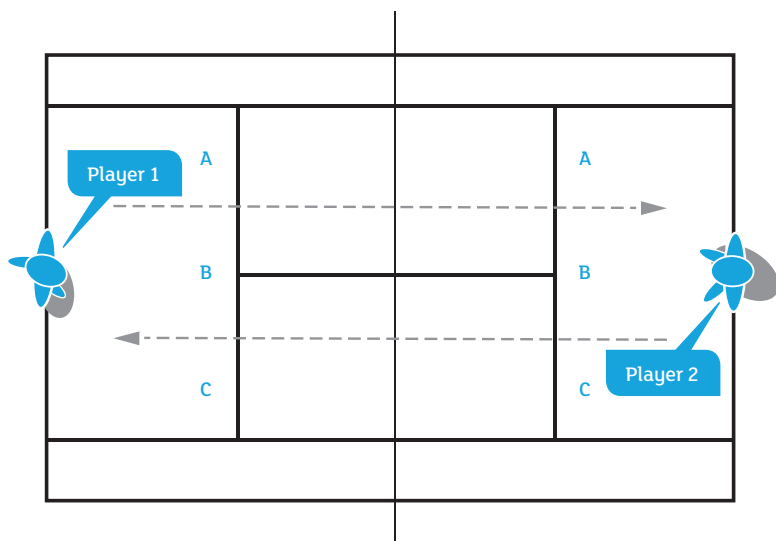

CONTACT

- At around waist height.
- A comfortable distance from body.

SWING

- Racket ready before bounce.
- Smooth low to high push/swing.

CO-OPERATIVE

- Divide court into 3 areas: A, B and C (see picture).
- Player 1 feeds the ball in underarm from the baseline and rallies cross court (A-C or C-A).
- Player 2 rallies down the line (A-A or C-C).
- Players aim for their longest rally.

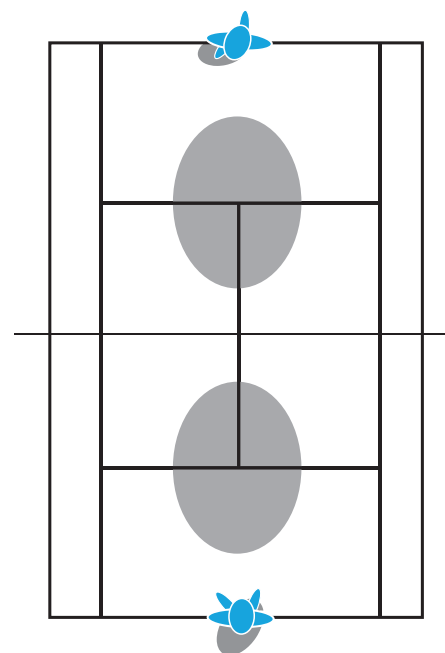

COMPETITIVE

- Rally of 4 P1 hits cross court & P2 hits down the line and play out the point.

COURT CONTROLLING

- Bonus points awarded if you use space effectively and move your opponent outside the tramline.

EASIER

- All practices can be made easier by using green, orange or red balls.
- Players trade B-B only using the forehand/backhand/alternate shots.
- Players trade and the ball may bounce anywhere inside the court area.
- Players trade and the ball may bounce twice inside the court area.
- P1 feeds and P2 hits (anywhere or to a target area, A, B or C).
- Both players throw and catch.

HARDER

- The practices above but ball must land behind the service line.
- **BLACK HOLE** – players lose point if ball goes in the black hole (see picture).
- Differentiation – only one player has the black hole.

DRILLS

Both Back 2

GAME SITUATION

Both back

STRATEGY

Consistency, getting the ball over and in, mainly focusing on moving opponent by controlling direction.

ORGANISATION

Players

- 2 players – working on one half of the court, using a yellow ball.
- 3 players – working on half a court. 2 at one end, rotate after each rally, player at the other end stays on.
- 4 players – as per diagram.
- 5 players – as per diagram with 5th player at the side of the court skipping. All players rotate one place to the left at the end of the rally.
- 6 players – two groups of 3. 1 player by themselves the other 2 at the other end, the 2 players rotate after each rally.
- 8 players – as per diagram with a waiting player behind each hitter, rotate after each rally.

Safety points

- With more than 2 players use cones to mark out safe area at the back of the court for waiting players.

KEY POINTS

- Set up: ready, read, react
- alert ready position
- judge ball and position back from the bounce

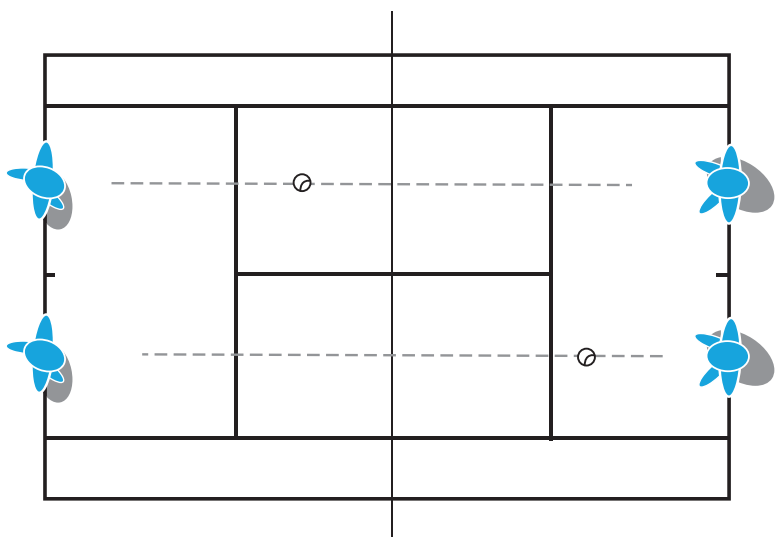

CONTACT

- At around waist height.
- A comfortable distance from body.
- A little further in front to hit cross court.

SWING

- Racket ready before bounce.
- Smooth low to high push/swing.

CO-OPERATIVE

- P1 feeds ball underarm to P2 and counts length of the rally.
- Using half the court including the tramlines.
- Players 3 & 4 rally on other half of court (see picture).

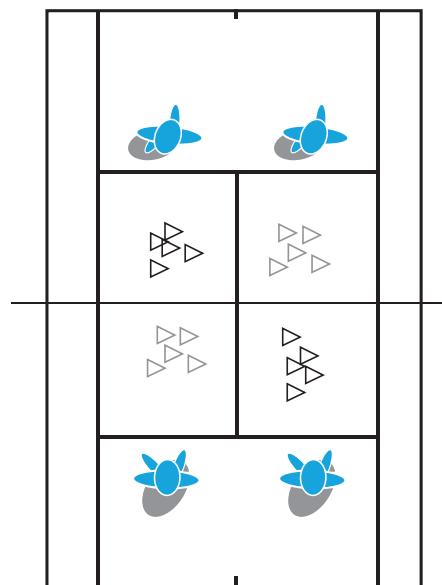

COMPETITIVE

- Rally of 4 and play out the point.
- Court controlling.
- P1 must keep P2 behind the baseline during the rally or points.
- P1 must stay inside the baseline during the rally or points.

COURT CONTROLLING

- P1 must keep P2 behind the baseline during the rally or points.
- P1 must stay inside the baseline during the rally or points.

EASIER

- All practices can be made easier by using green, orange or red balls.
- P1 feeds ball in from baseline and the ball may bounce twice inside the court area.
- Battleships – Each player has 5 cones placed close to the net on their half of the court. Players trade aiming for their opponents cones. The player who hits a cone wins must place it on their side of the court. The winner is the player with the most cones.
- One player feeds and the other hits.
- Both players throw and catch.

HARDER

- Players must prevent their opponent from stepping into the court area.
- One or both players must stay inside the baseline and take the ball early to take time away from their opponent.
- Players must trade keeping the ball past the service line.
- Differentiation – One player must hit past the service line, the other can hit anywhere in the court.

DRILLS

Both Back 3

GAME SITUATION

Both back

STRATEGY

Consistency, getting the ball over and in, mainly focusing on moving opponent by controlling direction.

ORGANISATION

Players

- 2 players – working on one half of the court, using a yellow ball.
- 3 players – working on half a court. 2 at one end, rotate after each rally, player at the other end stays on.
- 4 players – as per diagram.
- 5 players – as per diagram with 5th player at the side of the court skipping. All players rotate one place to the left at the end of the rally.
- 6 players – two groups of 3. 1 player by themselves the other 2 at the other end, the 2 players rotate after each rally.
- 8 players – as per diagram with a waiting player behind each hitter, rotate after each rally.

Safety points

- With more than 2 players use cones to mark out safe area at the back of the court for waiting players.
- If the ball goes into the wrong half, leave it.

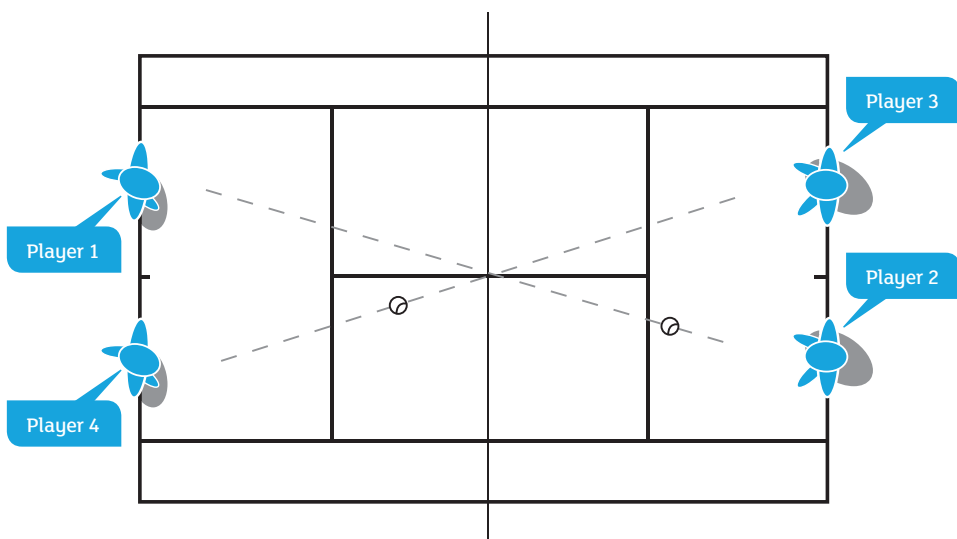

KEY POINTS

- Set up: ready, read, react
- Alert ready position
- Judge ball and position back from the bounce

CONTACT

- At around waist height
- A comfortable distance from body
- A little further in front to hit cross court

SWING

- Racket ready before bounce
- Smooth low to high push/swing

EASIER

- All practices can be made easier by using green, orange or red balls.
- P1 feeds the ball in from the baseline and rallies cross court with P2.
- P1 feeds ball in from baseline and the ball may bounce twice inside the court area.
- One player feeds and the other hits.
- Both players throw and catch.

CO-OPERATIVE

- P1 feeds ball underarm to P2 and rallies cross court counting the length of the trade.
- Using half the court excluding the tramlines, (see picture), players trade cross court and must only hit forehands/backhands and must recover to relevant area.

COMPETITIVE

- Rally of 4 and play out the point.

COURT CONTROLLING

- P1 must keep P2 behind the baseline during the rally or points.
- P1 must stay inside the baseline during the rally or points.

HARDER

- Players must make their opponent step outside the doubles tramlines.
- One or both players must stay inside the baseline and take the ball early to take time away from their opponent.
- Players must trade keeping the ball past the service line.
- Differentiation – One player must hit past the service line, the other can hit anywhere in the court.

DRILLS

Approaching the Net

GAME SITUATION

When approaching the net.

STRATEGY

Building by moving the opponent and taking time away.

ORGANISATION

Players

- 2 players – as per diagram, using a yellow ball.
- 3 players – 2 at one end, rotate after each rally, player at the other end stays on.
- 4 players – 2 at each end rotating after each rally (remember to swap opponents!)
- 5 players – 3 at one end, 2 at the other. Rotate after each rally.
- 6 players – 3 at each end. Rotate one end after each rally and the other end stay on for 2 rallies.

Safety points

- With more than 2 players use cones to mark out safe area at the back of the court for waiting players.

KEY POINTS

- Set up: ready, read, react
- Move towards the short ball but move to the side of it to allow room to hit

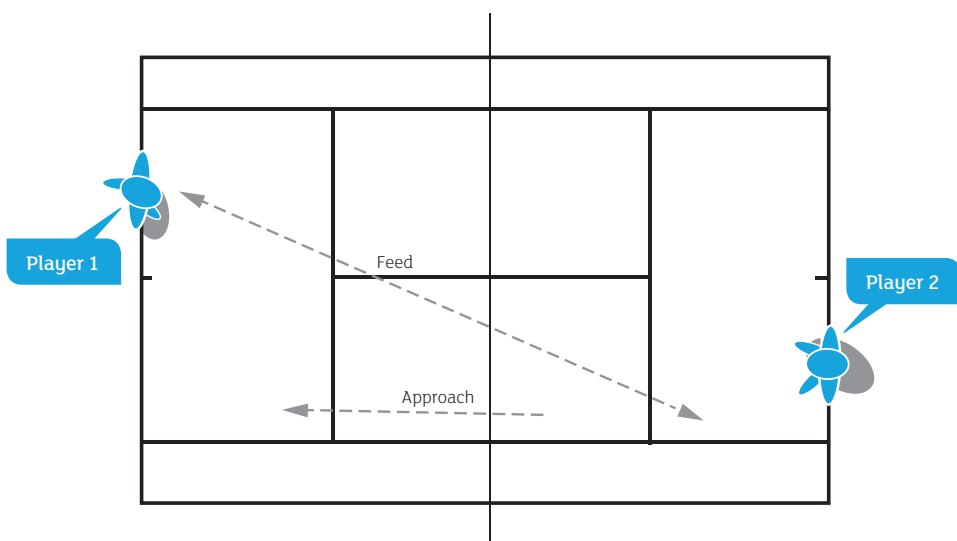

CONTACT

- Simple contact in front of body for volley
- keep the racket firm on contact.

SWING SHAPE:

- Low to high swing/push on approach
- little or no swing on volley.

CO-OPERATIVE

- P1 feeds short ball to P2.
- P2 approaches down the line and P1 returns so that P2 can volley.
- Player 1 feeds the ball in short from the baseline and P2 hits an approach down the line and follows the line to volley (see picture).

EASIER

- All practices can be made easier by using green, orange or red balls.
- P1 feeds ball in from baseline to P2 who is at the net and volleys it back.
- P2 starts at the net. Feeds ball in to be hit by P1 and then volleys.
- P2 shadows an approach shot and moves in. P1 hand feeds a volley.

COMPETITIVE

- P1 feeds short ball to P2.
- P2 hits approach and plays out the point.
- The point may be won either on the approach or subsequent volleys.

COURT CONTROLLING

- P1 feeds short ball to P2.
- P1 stays in same position and P2 hits approach to the space OR P1 recovers towards middle and P2 hits the approach back to where feed came from.

HARDER

- Players trade from the baseline and choose which ball to approach on.
- The approach shot must land in the back third of the court.
- Players must use their strength to play to the opponent's weakness i.e. forehand approach down the line to backhand.
- Differentiation – One player must hit the approach past the service line, the other player may hit the approach anywhere in the court.

DRILLS

Opponent Approaching or at the Net

GAME SITUATION

When opponent is approaching.

STRATEGY

Use time and space effectively.

ORGANISATION

Players

- 2 players – as per diagram, using a yellow ball.
- 3 players – 2 at one end, rotate after each rally, player at the other end stays on.
- 4 players – 2 at each end rotating after each rally (remember to swap opponents!)
- 5 players – 3 at one end, 2 at the other. Rotate after each rally.
- 6 players – 3 at each end. Rotate one end after each rally and the other end stay on for 2 rallies.

Safety points

- With more than 2 players use cones to mark out safe area at the back of the court for waiting players.

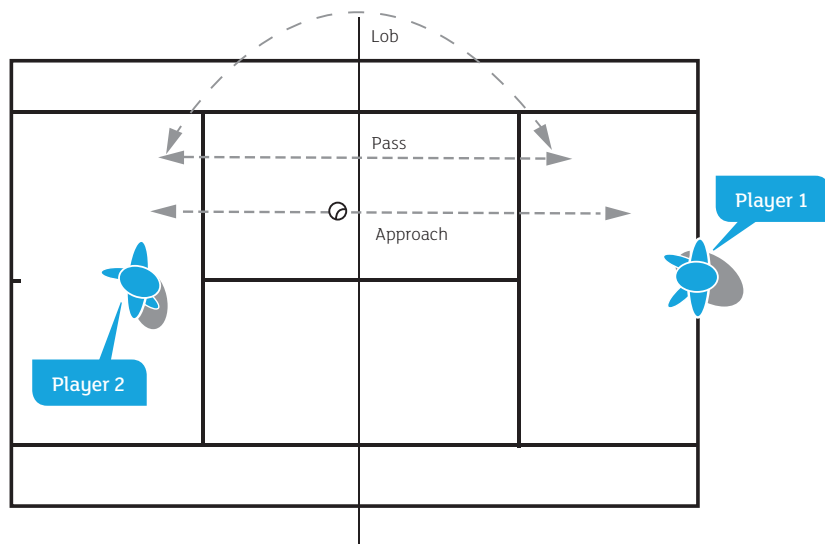

KEY POINTS

- Set up: ready, read, react
- Prepare while moving to the shot and keep head still.

CONTACT

- Contact in front of the body.

SWING

- Keep swing smooth under pressure from net player.

CO-OPERATIVE

- Player 2 starts halfway between service line and baseline, feeds the ball in deep to P1 who hits a passing shot or lob (see picture).
- Players have 10 turns as P1 to hit 5 lobs and 5 passing shots.
- Change roles.

COMPETITIVE

- P2 feeds and approaches.
- Players play out the point.

COURT CONTROLLING

- P2 feeds, P1 must either use spin to dip the ball at the incoming volleyer's feet or to hit it over their head with a lob.

EASIER

All practices can be made easier by using green, orange or red balls.

- P2 hand feeds ball from the net to P1 who can hit either a lob or a passing shot.
- P1 self feeds a lob or passing shot.

HARDER

- Players trade and choose when to approach so that the opponent must hit an attacking lob or passing shot.
- P1 must hit a lob or a passing shot to a target area.
- Differentiation – lobs only/ passing shots only.
- Forehands/backhands only.

DRILLS

When Serving and Returning

GAME SITUATION

When serving and returning.

STRATEGY

Consistency leading to using space effectively.

ORGANISATION

Players

- 2 players – as per diagram, using a yellow ball.
- 3 players – 2 at one end, rotate after each rally, player at the other end stays on.
- 4 players – 2 at each end rotating after each rally (remember to swap opponents!)
- 5 players – 3 at one end, 2 at the other. Rotate after each rally.
- 6 players – 3 at each end. Rotate one end after each rally and the other end stay on for 2 rallies.

Safety points

- With more than 2 players use cones to mark out safe area at the back of the court for waiting players.

KEY POINTS:

- Set up: ready, read, react.
- Take time on serve to get set up right.

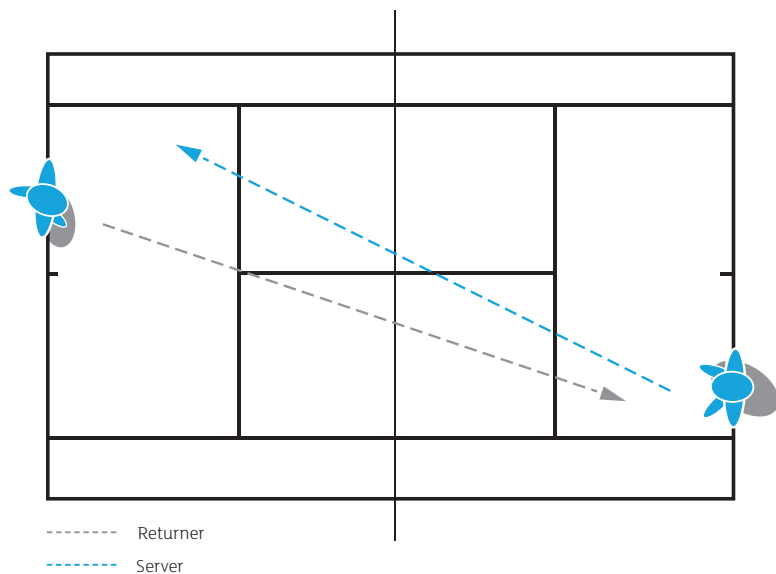

CONTACT

- Contact in front of the body on return.

SWING

- Keep swing simple on return to ensure that contact remains in front.

CO-OPERATIVE

- Player 1 serves to Player 2 who returns the ball cross court (see picture).
- P1 hits a 2nd shot to P2. Rally ends. Repeat with P2 as server.

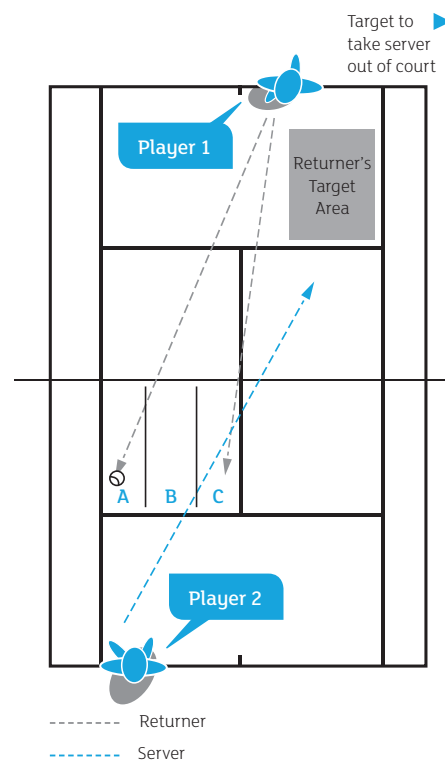

COMPETITIVE

- P1 serves to P2 to play out the point.

COURT CONTROLLING

- Server – Use spin or power for placement and pace to take your opponent wide or off the back of the court.
- Returner – 1st serve: down the middle and deep to cut off angles. 2nd Serve: step inside the baseline and take the ball early to take away server's time.

EASIER

All practices can be made easier by using green, orange or red balls.

Serving:

- Server may serve anywhere.
- Throw the ball in over arm.
- Server may serve underarm.

Returning:

- Return anywhere.
- Returner has to stop the ball with their racquet.
- Returner can then feed another ball in for the rally.

HARDER

Serving:

- Split service box into 3 areas (see picture).
- Player must hit serves either to A, B or C.
- Server must move opponent outside tramlines (see picture).
- Server must serve to either the opponent's forehand or backhand.

Returning:

- Returner must return to designated target area (see picture).
- Returner must return to server's forehand or backhand.

FUN GAMES

Racing Rallies

Teams rally on half/third of a court in service boxes. At one end, just behind the baseline, there is a team hoop with 3 balls inside.

- Players start on the service line.
- On 'go' Player 1 gets a ball from their hoop and returns to the service line to rally.
- When the team gets a rally of 10, Player 1 takes the ball and puts it in another team's hoop.
- Player 1 then gets another ball from their hoop and starts again.
- The winning team is the first one to have no balls in their hoop.

EASIER

- Use orange/green balls.
- Rally to 5.

HARDER

- Hit only backhand.

TIPS

Teams rally on half/third of a court in service boxes. At one end, just behind the baseline,

- You can have more than 2 in a team by rotating the players between rallies or shots.
- After 3 minutes, if there is no winner then the game stops and the team with least balls in their hoop wins.

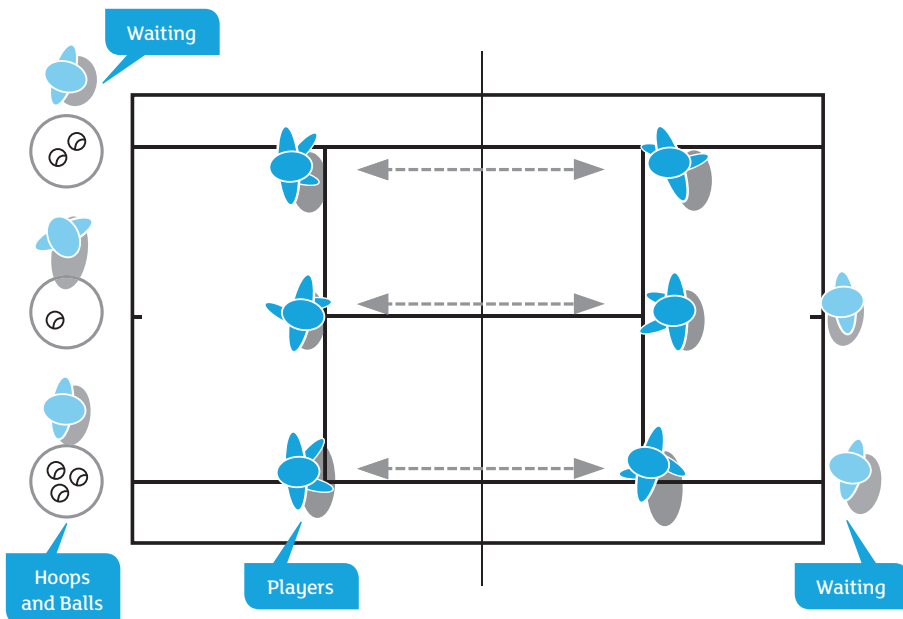
**ORGANISATION AND SAFETY**

- Spacing between teams.
- Loose balls.

KEY ELEMENTS COVERED

- Warm up.
- Pulse raising.
- Mobilisation.
- Stretching muscle groups.
- Forehand.
- Backhand.
- Movement around the court.
- Hit to partner.

LEARNING OUTCOMES

- Carry out warm up routines safely.
- Hit the ball with reasonable consistency and accuracy in cooperative rallies.

SCORING

- As per explanation.

EVALUATION

- Why are you warming up?
- What components of fitness has this focused on?

FUN GAMES

Waves

LEARNING OBJECTIVES

- To practise playing points in different court positions in a fun team format.

ORGANISATION

- Using the whole court, players in 2 teams all starting on the baseline.
- Coach feeds the ball in and the players play out the point.
- The team who win the point all move up to a mid court position, the other team stay on the baseline.
- Coach feeds the ball in and the players play out the point.
- If the team who are mid court win the point they move up to the net, if the team on the baseline win the point they move to mid court and the other team moves back to the baseline.
- Coach feeds the ball in and the players play out the point.
- The team that wins the point moves up the court, if they are at the net they stay there, the other team move back, if they are on the baseline they stay there.

ACTIVITY

- Explain the format and scoring to the players.
- The match is the first to 3 sets.
- A team needs to win three points in a row from the net to win a set.

AT THE END

- Declare the winning team.

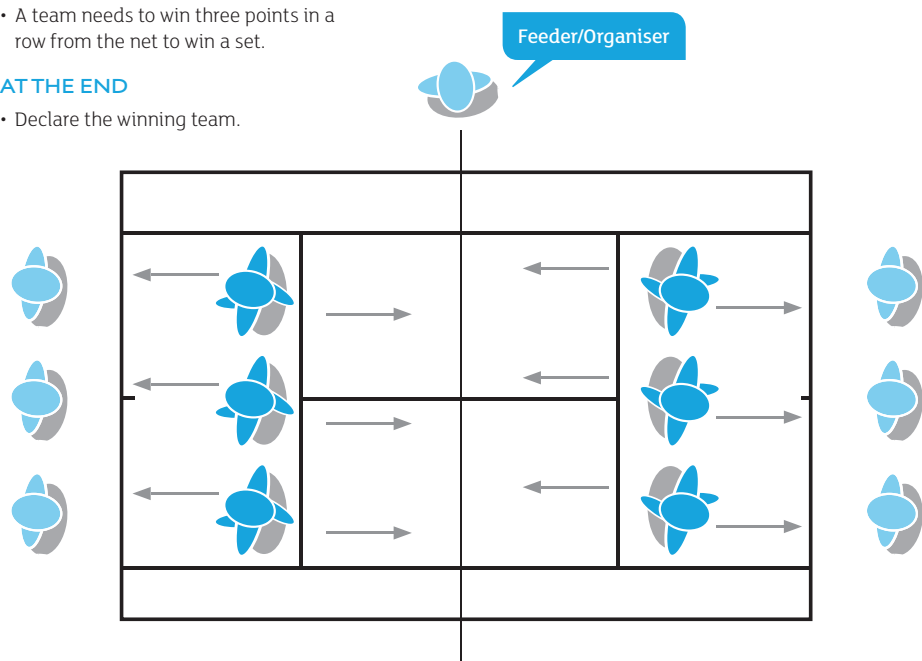

FUN GAMES

In and Out

LEARNING OBJECTIVES

- To practise playing points in different court positions in a fun team format.

ORGANISATION

- Using the whole court, players in 2 teams half of each team on the baseline and half at the net.
- Coach feeds the ball in and the players play out the point.
- When the point is over the player who lost the point leaves the court, they can come back onto the court when a member of the opposing team leaves the court.
- Coach feeds the ball in and the players play out the point.

ACTIVITY

- Explain the format and scoring to the players.
- The first set is played until all the members of a team are off the court.
- A team needs sets to win.
- At the end of each set players change ends.

AT THE END

- Declare the winning team.

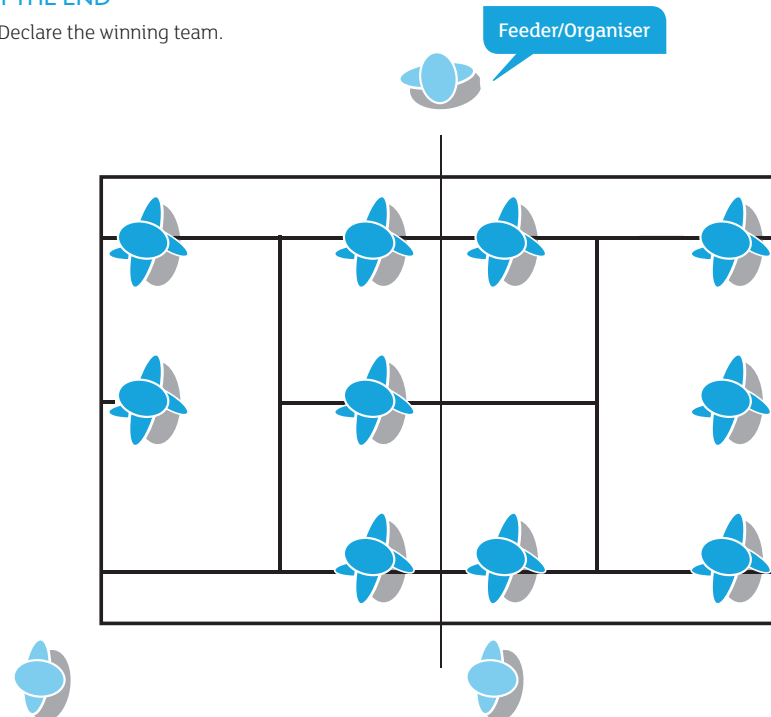

FUN GAMES

Round the World

LEARNING OBJECTIVES

- To practise playing points in a fun format

ORGANISATION

- Using the whole court, half of the players at the baseline at one end the other half at the other end (Safety tip, use a cone to keep players not on court behind).
- Coach feeds the ball in to player A who hits it to player B and then moves off the court and runs to the other end, Player B then hits it to player C (who has moved onto court once player A leaves) etc.
- When the point is over the player who lost the point loses a life, they have 3 lives.

ACTIVITY

- Explain the format and scoring to the players.
- The points are played until one player is left.

AT THE END

- Declare the winner.

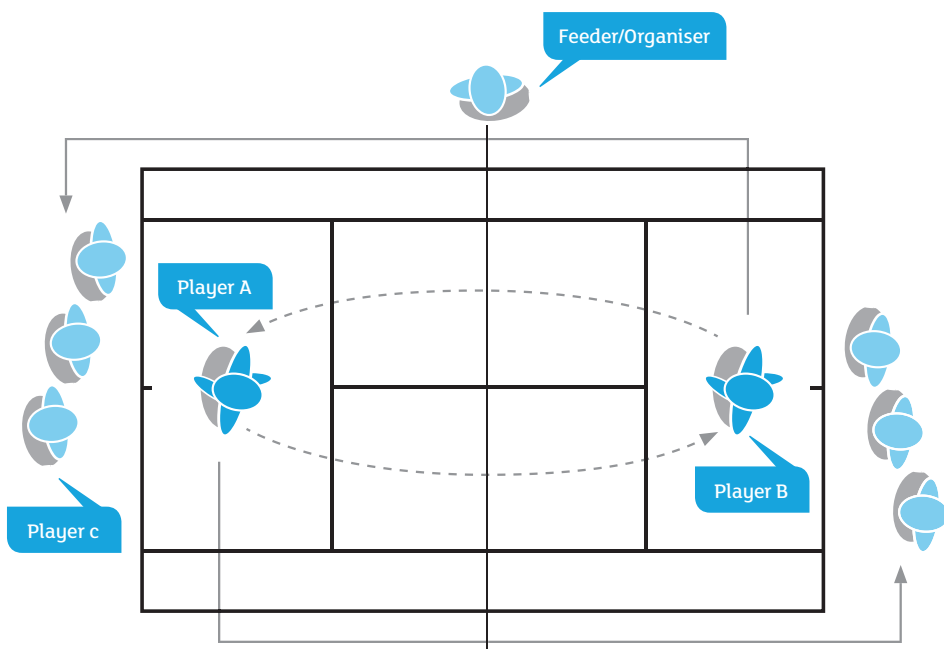

FUN GAMES

Triples

LEARNING OBJECTIVES

- To practise directing shots and covering the court as a team.

ORGANISATION

- Using the whole court, divide the players into 2 teams, half at each end. Three members of the team adopt 'on-court' positions; one at the net and two at the baseline. The other players stand off behind the court, but remain active by bouncing on the spot. The point is played with the six players on court. Once the point ends, each team rotate clockwise one position, then play another point.

ACTIVITY

- Explain the format and scoring to the players.
- Decide on a winning score, i.e. first team to win 9 points wins the game.
- Call out 'rotate' for the first few points to help them with the organisation.
- Look to feed the ball in each time so that the rally starts fairly.

AT THE END

- Declare a winning team.

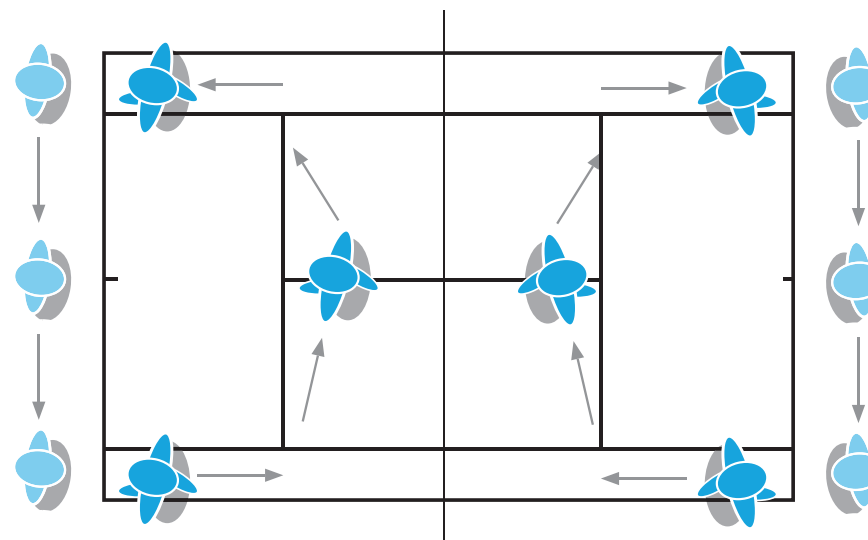



Leading

TENNIS SATELLITE
CLUBS TOOLKIT



Leading

Young people can take on many roles within tennis that will help prepare them for future careers and life experiences, making themselves more employable in the process. The Tennis Foundation / LTA provide free training and qualifications to support young people to achieve this. The opportunities outlined here also complement existing leadership schemes for young people such as Duke of Edinburgh Award or qualifications from Sports Leaders UK.

Design Your Club



This is where you can really give young people a chance to develop their leadership skills and give them a sense of ownership. Tennis is so much more than hitting a fluffly ball over a net! Tennis can provide opportunities for young people to develop a whole range of transferable life skills and build confidence through their experiences on the tennis court. For example, their communication, planning, organisation and vocational skills, as well as their self-esteem.

You could introduce the 'Design Your Club' concept and ask them to come up with their own ideas around how they would like to experience tennis, and also which particular aspects they might like to lead on. For example: social media/promotion, competitions, challenges, social events, buddy coaching, volunteering with events at the Hub Club or at school/ college. You could deliver the Tennis Leaders course to introduce leadership and then get the participants to group into teams reflecting their personal skills and the themes they would feel confident taking a lead on, each team could be responsible for leading on various elements of the club through the year and new recruits to the programme could feed in appropriately. You could build in some planning time within the sessions but hopefully they might also be able to do some planning outside of the sessions.

'Design Your Club' team themes:

- **Media/ Promotions** - Task a small group to launch an on-going social media campaign to promote the Tennis Satellite Club to other young people, spreading the word about tennis using Facebook, Twitter or YouTube.
- **Competitions** – One group could set up regular competitions with different formats each half term e.g. Short Tennis singles/ doubles/ team events, American Doubles, challenges with various competition stations.
- **Social events** – 'The socialites' of the group could plan a calendar of events e.g. 'Bring a mate night', 'Hit & BBQ', 'Tunes & Tennis' or 'Wimbledon strawberries & cream'.

'Design Your Club' focus on women and girls:

- You could recruit a 'Girls Champion' to consult with the young women and girls participating at your Tennis Satellite Club, find out what type of tennis experiences they would enjoy most and empower the 'Girls Champion' to take a lead on setting the right atmosphere and ensuring competitive formats are appropriate.

VOLUNTEERING AT LOCAL EVENTS

Volunteering in tennis is a great way for young people to build upon their skills and experiences and increase the opportunities available to them in employment. There are lots of ways young people can get involved in volunteering in tennis including helping to organise competitions, becoming a tennis leader or attending a young volunteer event.

If the Hub Club needs to recruit more volunteers to increase capacity on the junior programme, the young people at the Tennis Satellite Club could be made aware of these opportunities and encouraged to help out with the junior programme or events at the Hub Club. This could also support transition from the Tennis Satellite Club to the Hub Club programme.

Consult with the committee at the Hub Club and compile a list of the volunteering opportunities and events where extra volunteers may be required, ensuring each event has a dedicated point of contact. You could pass this information onto young people at the Tennis Satellite Club who may be interested in gaining more leadership and volunteering experience.

To find out about other volunteering opportunities in tennis locally, please contact your local LTA county office.



TENNIS LEADERS

Tennis Leaders is the first step on the tennis and sport career pathway for volunteering and potentially, paid employment. It has been designed to offer a wide range of opportunities to young people aged 13 years plus, providing them with enhanced leadership skills and experience.

There are five Tennis Leaders modules, complete the core module before working through any of the additional four modules: Core module introduction to tennis (three hours); volunteering at your tennis venue; leading a practice session; helping at your school; helping at a competition (two hours per additional module). As a minimum, to receive their free certificate and T-shirt, participants will need to complete the core module plus one additional module.

Tennis Leaders can now be delivered by qualified and active teachers/ lecturers as well as licensed and registered coaches (Level 3 upwards) without the need to go on any specific training. All you need is the Tutor Workbook and Tennis Leaders Workbooks which are available free of charge from your local Tennis Development Manager and LTA county office.

You could deliver the Tennis Leaders course to introduce leadership and build upon this by grouping the participants into teams and then give them specific responsibilities to lead on various elements of the club through the year.

Free

from your local Tennis Development Manager and LTA county office



COMPETITION ORGANISER WORKSHOP

In order to get more people competing, there need to be more opportunities to take part in local competition. Since 2008, British tennis has trained over 4,000 16-25 year olds as Competition Organisers to ensure we have enough people to meet demand and deliver high quality events and tournaments.

A free three-hour workshop, designed specifically for 16-25 year olds, can be delivered locally by our Tennis Development Managers and selected others, to provide the skills to run a range of competitions. At the training, attendees will be given a Competition Organisers Toolkit, providing them with all of the tools and resources needed to run competition. Competition Organisers can then play an important role in ensuring we keep more young people in the sport.

More info...

- To find out about hosting one of these courses, please contact your local LTA county office. Contact details can be found at: www.schoolstennis.org



Design Your Club



- You can introduce various competition formats by delivering the Tennis Leaders module 'helping at a competition' and as a follow on for those interested in developing their skills further, you can signpost them to attend a local Competition Organiser Workshop.
- Your new Competition Organisers can then help to organise some intra competitions at the Tennis Satellite Club and assist with events at the Hub Club or Host Site or inter-venue competition against other local Tennis Satellite Clubs.

Competing

Competing 218

Mix & Match Competition Cards 221

Competing

Young people of all ages and abilities love to compete, so it's important they are taught the rules of the game - how to score, win points and basic rules. The Toolkit provides lots of ideas, formats and templates for incorporating regular competition into the programme.

INTRA COMPETITION *(within the club)*

Intra competition within the Tennis Satellite Club programme is a great way of engaging all young people in meaningful, regular and fun competitions.

- Try to ensure competition appears weekly in your coaching programme by using the competition themed activity cards in the toolkit, or set up challenges with various competition stations.
- At the end of every half term run a different type of competition e.g. Timed tennis formats for Short Tennis or traditional tennis singles/doubles, team events, American Doubles.
- Timed tennis formats are great, as you can plan exactly how long the matches will last and therefore the overall time your competition will take, with the number of players and courts you have available.



INTER COMPETITION *(between venues)*

Where there are local clusters of Tennis Satellite Clubs, why not develop some friendly local rivalry through inter venue competition. The toolkit provides various options for team based events and both 'Squad Tennis' or 'Team Round Robin' provide ideal formats. These are team events for teams of four players, with players in a team ranked in order of standard to ensure better standard players from each team play each other, and you can incorporate singles and doubles matches. You can either set up a league, one-day event, or just play some inter venue matches on a termly or half termly basis.

'Team Round Robin' can be found on page 50.

'MIX AND MATCH' COMPETITION CARDS

The competition cards help players to get to grips with scoring and the different ways of winning points. Most of the activities included can be adapted to cater for Short Tennis or traditional tennis delivery.

Don't forget to refer to the School Games Tennis Toolkit CD-Rom included at the back of this toolkit, which contains more than 40 resources and templates, many of which can be edited.



Design Your Club



- *Setting up regular informal competition is an excellent way for young people to learn the rules, keep score, record results, organise box leagues and promote Fair Play. If they gain more confidence in this area it might encourage them to get involved in further leadership and volunteering opportunities inside and outside the Tennis Satellite Club.*
- *If you have a 'Competition Organisers Group' you can task them to set up regular competitions with different formats each half term.*
- *Nominate team captains and an overall team manager for the inter venue competitions, rewarding those who are good role models or aspiring leaders.*
- *If you have a 'Media/Promotions Group' they could produce press releases and reports following the competitions, interview the participants for quotes and stories, promoting these via social media channels. You could also encourage them to make contact with the local press and ask if they would be interested in running a feature on the Tennis Satellite Club and how it promotes tennis in the local community, with an angle on young people taking a lead on the design and running of the sessions.*



Mix & Match COMPETITION CARDS



COMPETITION

Winning a Point

QUALITY POINTS

- Watch carefully.
- Call out loudly and clearly.

LEARNING OBJECTIVES

- Recognise the 5 basic ways to win a point.

Opponent misses the ball...

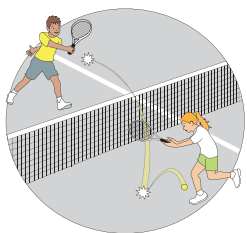

...or hits the ball into the net...

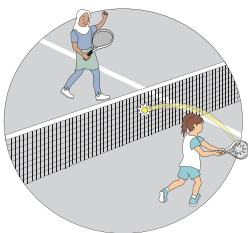

...or hits the ball out

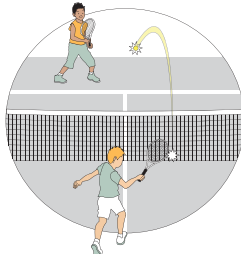

The ball bounces twice before opponent hits it...

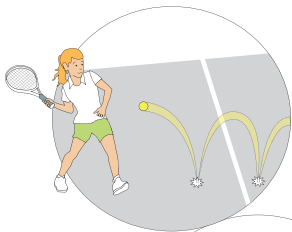

Opponent serves a double fault

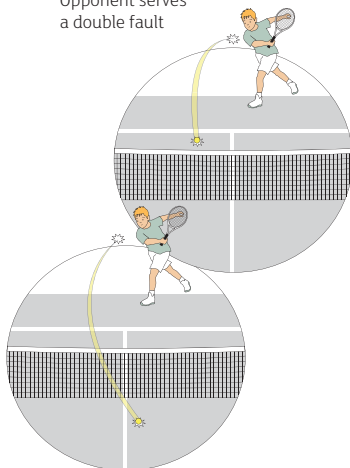

Wheelchair users are allowed 2 bounces

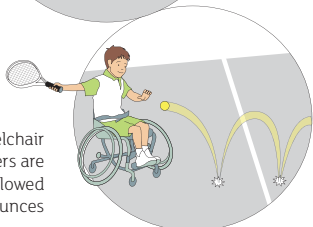

ORGANISATION

For players who can serve and rally and have an understanding of in and out and the court area.

- Position players at the side of the court and demonstrate.
- Organise players into groups of 4 on each court area – 2 play singles and 2 are observers.

ACTIVITY

Do activities in order. Explain and demonstrate the 5 ways to win a point:

- Opponent misses the ball.
- Opponent hits the ball in the net.
- Opponent hits the ball out.
- The ball bounces twice before the opponent hits it (except for wheelchair players).
- Opponent does a double fault.

Two players play points whilst the observers look for what happens when the point finishes. Players take turns to serve. Observers call out what happened and who won the point. e.g. 'The ball was out, Sally wins the point'. 'Ahmed hit the ball in the net, so Harry wins the point'. There is no need to count the score at this stage. Rotate the players and observers after every 4 points.

EASIER

- Introduce 1 way of winning a point at a time and observers look for that only.
- Play Catch Tennis.

HARDER

- Observers state who won the point without giving the reason.
- Players call out who won the point and observers check.

DISCOVER

- What are the 5 ways you can win a point?
- When can you win a point without hitting a ball?
- What do you do if you see the ball bounce twice?
- How many bounces are allowed in wheelchair tennis?

COMPETITION

In 4s. 2 players play points with alternative serves. At the end of every point the player who won the point has to give the reason. 2 observers are judges and award the point winner a cone for a correct answer. After 4 points players and observers change roles. After a set time the overall winner of the court is the player with the most cones.

COMPETITION

Scoring a Tie Break

QUALITY POINTS

- Watch carefully all through each point.
- Agree the score before the next point.
- Call the score loudly and clearly.

LEARNING OBJECTIVES

- Count points.
- Understand the serving order in a tie break.

ORGANISATION

For players who can rally and understand how to win a point. Use Winning a Point.

- Equipment: rackets, balls, cones.
- Define the court area for matches. At the side of the court put a row of 7 cones for each player. At each end of the court behind the server put a red cone on the right side and another colour cone on the left side.
- Position players at the side of the court and demonstrate the order for serving.
- Highlight the safe use of rackets.
- Organise players into 4s. 2 players, and 2 observers on each court.

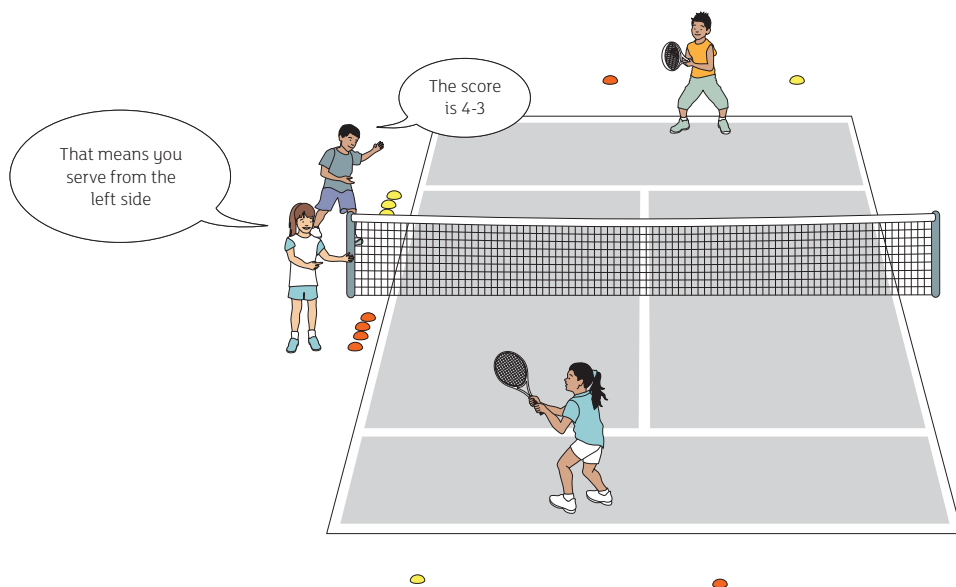

ACTIVITY

Two players play points. Player 1 serves first from the Right side for one point. Player 2 then serves one point from the Left side and then 1 point from the right side. Player 1 then serves from the Left then Right and so on. Observer 1 is scorer and watches, and for each point puts a ball on the winner's row of cones, and calls the score. Observer 2 watches the serving order and points to the correct server and the correct side. Stop at the end of each point and agree the score before the next point.

EASIER

- Introduce just counting the points then adding serving order later.
- Play Catch Tennis or Floor Tennis.

HARDER

- Players score themselves using cones. Observer or players count the score without cones.
- Score and serve correctly in a doubles match.

DISCOVER

- How do you decide who serves at the beginning of a match?
- Which side does the first serve come from?
- If the number of points in total is an odd number which side does the server serve from?

COMPETITION

Team Quiz: The answer to each question is a number. Each team runs and puts that number of cones on their team cone stack. At the end count up the total number of cones in the stack and see which team has the correct number of cones. Use some or all of the following example questions and add your own:

- How many points to win a normal tie break?
- If you are the first person to serve how many points do you serve?
- If you are the second person to serve how many points do you serve?
- In a singles match if the score is 4-3 which side do you serve from? 2 cones for R, 1 cone for L.

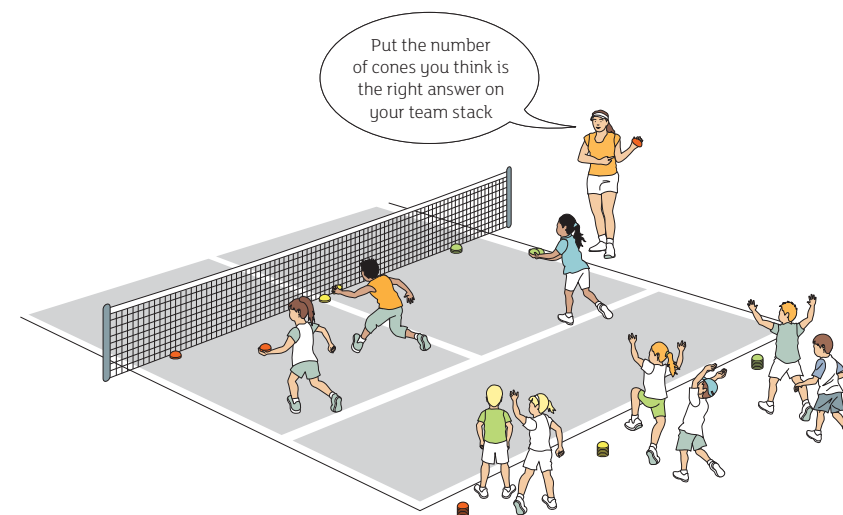

COMPETITION

Tips for Tie Breaks

Tie break scoring is the best scoring format for Mini Tennis. Use it flexibly in sessions to suit your time and court availability.

OPTIONS ARE:

- Play a normal tie break to 7 or a match tie break to 10.
- Play a shortened tie break to any number you choose.
- Play a timed tie break.
- Play a set number of points – an odd number if you want a winner, an even number if you are happy to allow ties.

TIMING GUIDE

Matches are usually slightly quicker in Red than Orange and Green.

Approximate times are as follows:

Tie break to 7	7 mins
Match tie break to 10	10 mins

Avoid playing 2 clear points in sessions where timing is important.

HOW TO FILL IN THE SCORE SHEET

Use one column for each point and accumulate the score (1-2-3 etc) as the tie break progresses, so that you can see the score quickly.

See the example below:

Name:	R			L	R			L	R			L
Sally Server	1	1	2	3	4	4	4	4	4	4	5	5
Name:		L	R			L	R			L	R	
Robbie Receiver	0	1	1	1	1	2	3	4	5	6	6	7

Name:	R			L	R			L	R			L	R		
Name:		L	R			L	R			L	R			L	R

Change ends after each 6 points if appropriate

Winner:	Score:
----------------	---------------

Name:	R			L	R			L	R			L	R		
Name:		L	R			L	R			L	R			L	R

Change ends after each 6 points if appropriate

Winner:	Score:
----------------	---------------

Name:	R			L	R			L	R			L	R		
Name:		L	R			L	R			L	R			L	R

Change ends after each 6 points if appropriate

Winner:	Score:
----------------	---------------

Get extra copies: Photocopy this original

COMPETITION

Team Cones

LEARNING OBJECTIVES

- To use skills and enjoy the experience of matches in a team competition.

ORGANISATION

- For players who understand how to win and score points.
- Have 2 sets of coloured cones.
- Divide players into 2 teams: can be same or different numbers.

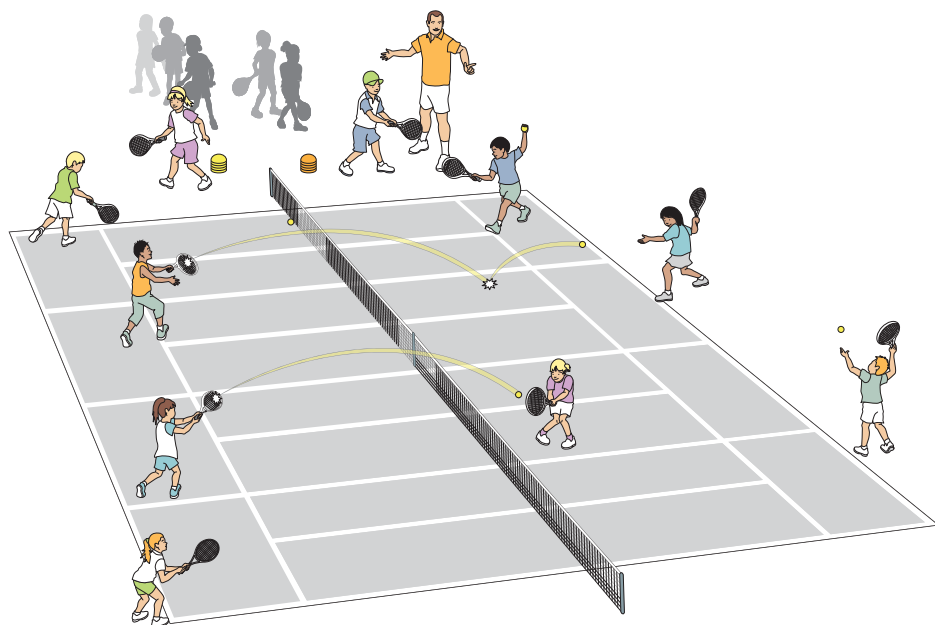

ACTIVITY

- Explain to the players they will play some singles matches and when they win a match they win a cone for their team. The team with the most cones at the end is the winning team.
- Line each team up behind one team cone.
- The first player in each line goes to court 1, next 2 players on court 2, etc.
- Each match is to 4 points.
- If players need help with scoring see 'Scoring a Tie Break.'
- At the end of each match the winning player puts a cone onto the team cone stack and they both join the back of their team line.
- The next 2 players go to the free court.
- If the teams have different numbers the player rotation will happen naturally. If they have the same number, organise players so they have different matches.

AT THE END

- At the end, count up the team cones and declare the winning team.

COMPETITION

Round Robin Group

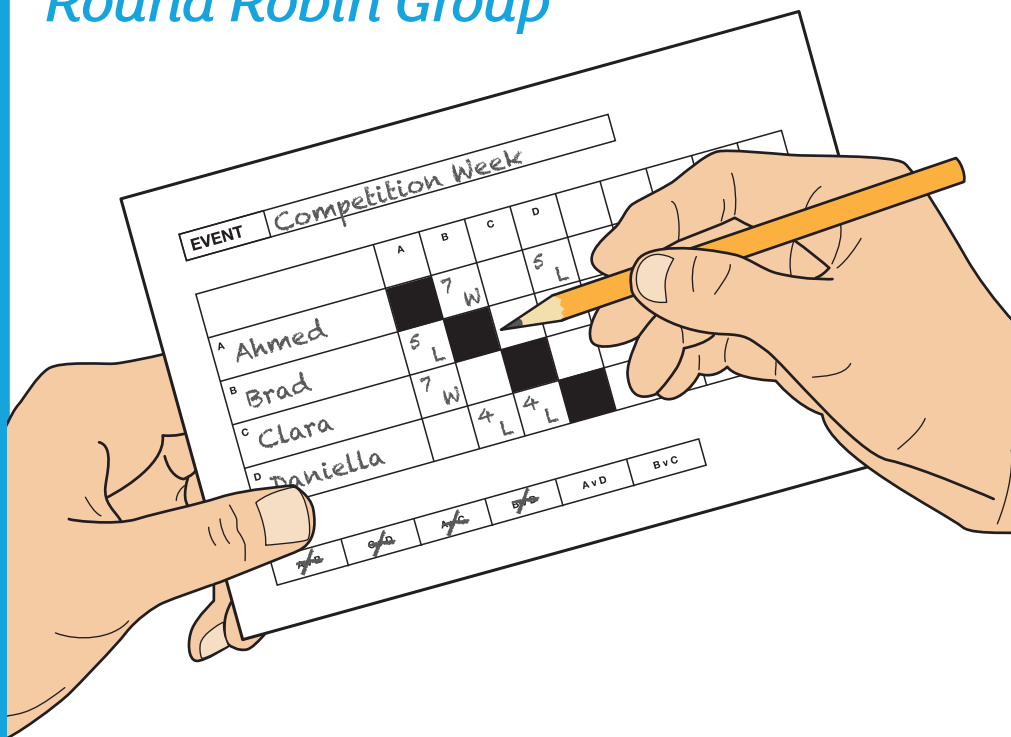

LEARNING OBJECTIVES

- To experience playing matches in an individual competition.

ORGANISATION

- For players who know how to win and score points.
- Copy an appropriate scorecard and insert player names.
- Work out a scoring length. e.g. For 4 players on 1 court there are 6 matches. A tie break to 7 takes 10 mins. The group would take 1 hour.

ACTIVITY

- Explain to the players how the group will work, the scoring, and how the winner is calculated.
- Follow the order of play.
- Tell players what to do when they are not playing, where they wait or help with scoring.
- Plan ahead and have the players for the next match ready to go on court.

COMPLETING THE SCORES:

- Record results as matches finish.
- Put a player's score in the horizontal box in the opponent's column for both players in each match.
- The winner is usually the player with the most wins. If there is a 2 player tie, take the winner of the match between them. In the rare occurrence of a 3 player tie, calculate the percentage of points won of the number of points played.

Sample completion of a box: for a group of 4 players with matches of one tie break game to 7.

Group	A	B	C	D	Wins	Points for	Points played	Positions
A Ahmed		7 W	5 L	3 L	1	15	34	4 (44%)
B Brad	5 L		5 L	7 W	1	17	35	2 (48%)
C Clara	7 W	7 W		7 W	3			1
D Daniella	7 W	4 L	4 L		1	15	32	3 (47%)

VARIATIONS:

- For young players let all points count and the player with the most points wins. State this at the beginning.

AT THE END

- Announce the winning player for each group.

COMPETITION

Timed Tennis

WHAT EQUIPMENT & FACILITIES ARE NEEDED?

- Tennis court (full size, or Short Tennis).
- Tennis balls and rackets.
- Whistle or claxon!

ORGANISATION

- Four players per court for doubles and two players per court for singles.
- You can use the Round Robin Group competition card to allocate the players into boxes and check how many matches will be played per box. Depending upon how many courts you have available you can then work out how long the matches need to be to suit the time frame you have. For example, with four players in a box on one court, there are six matches to be played. If you play 8 minute matches with a 2 minute break between each match the group would take 1 hour.

RULES

- Use tie-break / Short Tennis scoring and rules.
- Matches start at the sound of a whistle and last for a set period of time, until the whistle blows. The length of matches depends on time available and amount of entries eg. 10 minute matches. Players to finish a point if started when the time is up.
- If scores are equal after the allocated number of minutes a deciding point is played.
- No need to change ends if playing indoors.
- Players should be encouraged to be as quick as possible between points.
- Timed matches can be ideal for running competitions as you can plan exactly how long matches will last and therefore the overall time your competition will take.

FORMATS

- Matches and leagues can run on a singles or doubles basis

TIMED TENNIS TEAM EVENT

- This can work well as a team event with teams of 4 players (male/female/mixed teams). Players in a team should be ranked in order of standard to ensure better standard players from each team play each other.
- As teams are made up of 4 players, each match between two teams consists of 4 separate rubbers:
 - Team A Player 1 v Team B Player 1 Singles
 - Team A Player 2 v Team B Player 2 Singles
 - Team A Player 3 v Team B Player 3 Singles
 - Team A Player 4 v Team B Player 4 Singles
- Each 'match' is set off to play on 4 courts and the final score entered onto the 'Match Scorecard' and then the 'Round Robin Box Sheet' would either be; 4-0, 3-1, or 2-2 – taking into account the individual results from each of the 4 rubbers.
- These scores then add up to give a total points score for each team.
- Individual match points can also be tallied in case of a tie.
- The format is flexible and you could just play 2 doubles matches or have 2 singles matches and 1 doubles match.
- There are a range of example timings/ formats, match scorecards and tie-break score sheets included in the School Games Tennis Toolkit CD-ROM.

COMPETITION

Hit & Mix Doubles Competition / American Doubles

- A 'Hit & Mix' doubles competition (also known as American Doubles) works on the basis that players play for a fixed period of time or for a certain number of games with one partner against their opposition.
- The pairings change each round, see below for working out the rotations.
- This competition format is ideal for social tennis events, but ideally you need multiples of 4 so you can have everyone playing doubles at the same time.

FORMAT

1. **Split the players** – Split the players into 2 groups depending on the competitors this could be male/female or based on ability levels eg. team/ non-team players.
2. **Label the courts** – Make sure all the players know which court is court 1, 2, 3 etc.
3. **Deciding the pairs** – The players always play with someone from the other group. This could lead to mixed doubles if you set up male/ female groups.
4. **Length of the match** – Decide on the length and number of matches. Matches should be a set number of games or points (must be an odd number) or the matches could be timed e.g. 10/20 minutes.
5. **Create player cards** – Create player cards and hand out so each player knows how they give in their score and where they move after each round (one team have the white cards, the other team have the grey cards). See templates in the School Games Tennis Toolkit CD-ROM.
6. **Play the first match** – After the first match the winners 'move up a court' (e.g. If playing on 3 courts: court 2 winners move to court 1, court 3 winners move to court 2 and court 1 winners move to court 3) and separate so the winning pair are playing against each other in the next match. Runners-up stay on the same court and separate.
7. **Determining a winner** – The competition organiser counts up the scores at the end. The winners are (a) the player from the white card group who has the highest score and (b) the player from the grey card group with the highest score.
8. **Hand out the prizes!**

COMPETITION

Squad Tennis

- Squad Tennis is a simple team event for groups of players (teams of 4 work best).
- Players in a squad should be ranked in order of standard to ensure better standard players from each squad play one another. Players play one singles and one doubles match. So with squads of 4 players you will end up playing a total of 6 matches against your opposing squad (4 singles and 2 doubles).
- The length of each match can be flexible depending on the time and courts available.
- The squad that wins the most matches wins. You can either set this up as a league, one-day event, or just set up squad matches on an ad hoc basis.
- In the event of a tie at 3 matches each, a 'tie-break shoot out' can be played. A 'tie-break shoot out' shall consist of two singles tie-breaks (to 7 points, with 2 clear) which are to be played at the same time followed by a doubles tie-break (to 7 points, with 2 clear) if necessary. No player may play in more than one tie-break.

Players are to be nominated as follows for the 'tie-break shoot out':

- **Tie-break 1 (singles):** One of the original players from the 1st/2nd singles match.
- **Tie-break 2 (singles):** One of the original players from the 3rd/4th singles match.
- **Tie-break 3 (doubles):** A pairing comprising any two of the other players who have played in the match.

SCORE CARD FOR 4 PLAYERS IN A TEAM

	Team Murray		V		Team Djokovic	
	Player	W/L	Score	W/L	Player	
Singles/Doubles						
Singles 1						
Singles 2						
Singles 3						
Singles 4						
Doubles 1						
Doubles 2						
Total no. of wins						

Order of play - This type of format can be played on 3 courts

First round	Player 1 v Player 1	Player 2 v Player 2	Doubles 2 v Doubles 2
Second round	Player 3 v Player 3	Player 4 v Player 4	Doubles 1 v Doubles 1

SCORE CARD FOR 6 PLAYERS IN A TEAM

Singles/Doubles	Team Federer		V		Team Nadal	
	Player	W/L	Score	W/L	Player	
Singles 1						
Singles 2						
Singles 3						
Singles 4						
Singles 5						
Singles 6						
Doubles 1						
Doubles 2						
Doubles 3						
Total no. of wins						

Order of play - This type of format can be played on 5 courts in the first round and 4 courts in the second round

	Player 1 v Player 1	Player 2 v Player 2	Player 3 v Player 3	Player 4 v Player 4	Doubles 3 v Doubles 3
First round					
Second round	Player 5 v Player 5	Player 6 v Player 6	Doubles 1 v Doubles 1	Doubles 2 v Doubles 2	

COMPETITION PLANNING GUIDELINES

Once you have decided you want to run a tennis event or competition, it is worth considering the following:

Before

- What type of event do you want to organise?
- Who are you hoping to attract and what will they want?
- What costs are involved?
- When are you going to run the event?
- Book the courts needed and recruit a team to help organise the activity or event and make sure the right equipment is available.
- Organise any prizes.
- Create an order of play, set of rules, or relevant format/structure for the competition.
- Think about whether people will feel they've had a good opportunity to play and meet people, especially if it's a social day or event.
- Confirm all entries and ensure they understand the format of the event. How long are they likely to be there and how many chances to play will they have?
- Decide on any social activities alongside the event e.g. SwingBall, music, etc.
- Train your helpers and let them know what they'll be doing on the day in advance so they can prepare. Be prepared for sudden last minute entries, drop outs and no shows – have a back-up plan.
- Explain what will be achieved during the event.
- How and where will you market or promote what's happening?
- Promote the activity or event in advance, perhaps with posters, sign-up sheets, entry forms, via social media or websites.
- You can access template posters by registering at: www.allplaytennis.com

P.T.O...

During

- The experience people have during an event or competition will affect their satisfaction and – for new recruits in particular – whether they come back. Here are some tips to help people feel welcome and ensure you deliver a good experience for all.
- Arrive in good time and set up any necessary equipment; mini courts, nets, lines, etc.
- Put up copies of the rules and format so that people can read before the event starts.
- Try and stick to the schedule and keep encouraging players throughout.
- Deal with any queries or questions in a polite and efficient manner
- Take some pictures or even some video footage which can be used to report on the event afterwards.
- Enjoy it!

After

- Get feedback from those who took part; get new ideas and find out what works.
- Thank all the helpers as well as those who took part – they will feel valued and more inclined to take part in another event.
- Raise some awareness post event with pictures and a write up on your website, Facebook page, noticeboards and the local press.
- Ensure everyone who took part knows when the next event is taking place.

SCHOOL GAMES TENNIS TOOLKIT

The School Games Tennis Toolkit is an interactive CD-Rom, which has been designed for teachers and the school sport infrastructure, to make competition in schools as easy to run as possible. The toolkit contains more than 40 resources and templates, many of which can be edited.

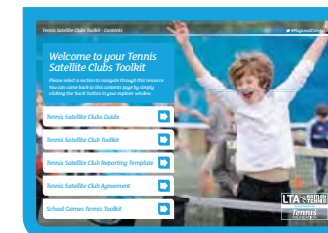

Packed with **over 40** editable resources and templates

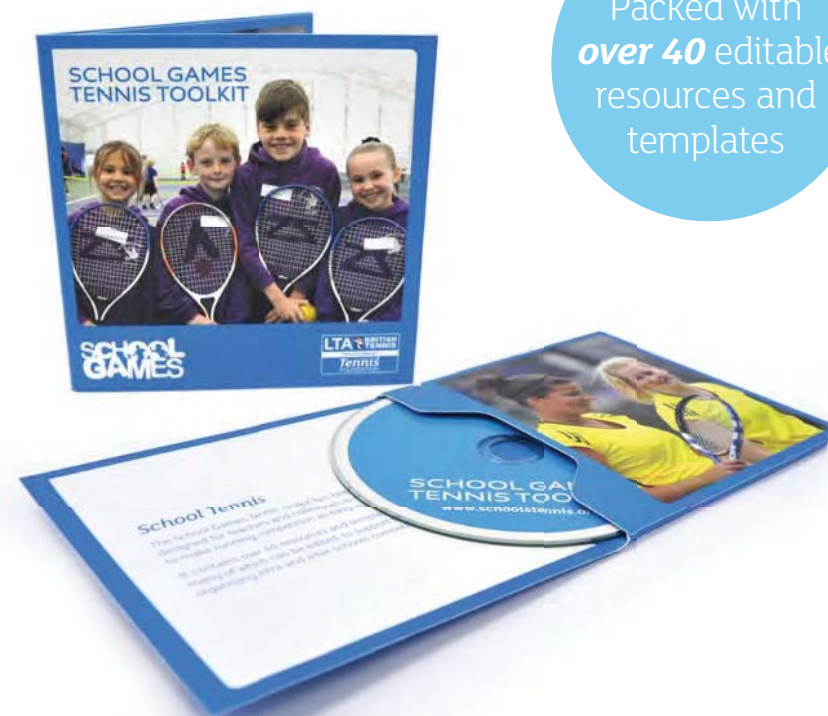

AEGON TEAM TENNIS SCHOOLS

Aegon Team Tennis Schools is a programme of three nationally organised competitions that provides young people in secondary schools and further education colleges with the opportunity to play regular competitive tennis and to represent their school/ college. All competitions begin locally and culminate in a national final. All competitions are free to enter and only four players are required for a team. Responsibility for organising these competitions lies with the LTA and the Tennis Foundation at a national level with support from a network of local league organisers.

■ Aegon Team Tennis Schools Year 8&10 (2014 - Entries open December 2013)

For players of all abilities to play in localised leagues (either division 1 or division 2) with local organisers, with more successful teams able to progress on a pathway to a National Final.

■ Aegon Team Tennis Schools Senior Students (2014/15 - Entries open June 2014)

For players of a lower rating, or no rating, in Years 11-13 to play competitive tennis and provide teams with an opportunity to compete in a National Final.

■ Aegon Team Tennis Schools National Championships (2014 - Entries open December 2013)

Become the best school tennis team in the Country!

The PE / sports staff at schools and colleges are responsible for entering teams into the above competitions, however in some cases, staff may not be aware that they have young people in their school or college who are playing tennis and up for entering competitions. Coaches are encouraged to make sure that young people at Tennis Satellite Clubs are aware of the competitions, so if they are interested they can go back to their sports staff and encourage them to enter the appropriate event.

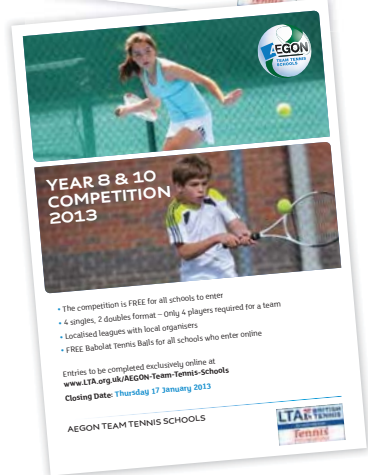

Scan the QR code to find out more about Aegon Team Tennis Schools or visit: www.LTA.org.uk/Aegon-Team-Tennis-Schools



Produced by The Tennis Foundation | Charity No. 298175
For more information visit: www.tennisfoundation.org.uk

Photographs supplied courtesy of Getty Images, Roy Smilijanic Photography, James Jordan Photography and Victoria Davies.



**CREATING
CHANCES**

